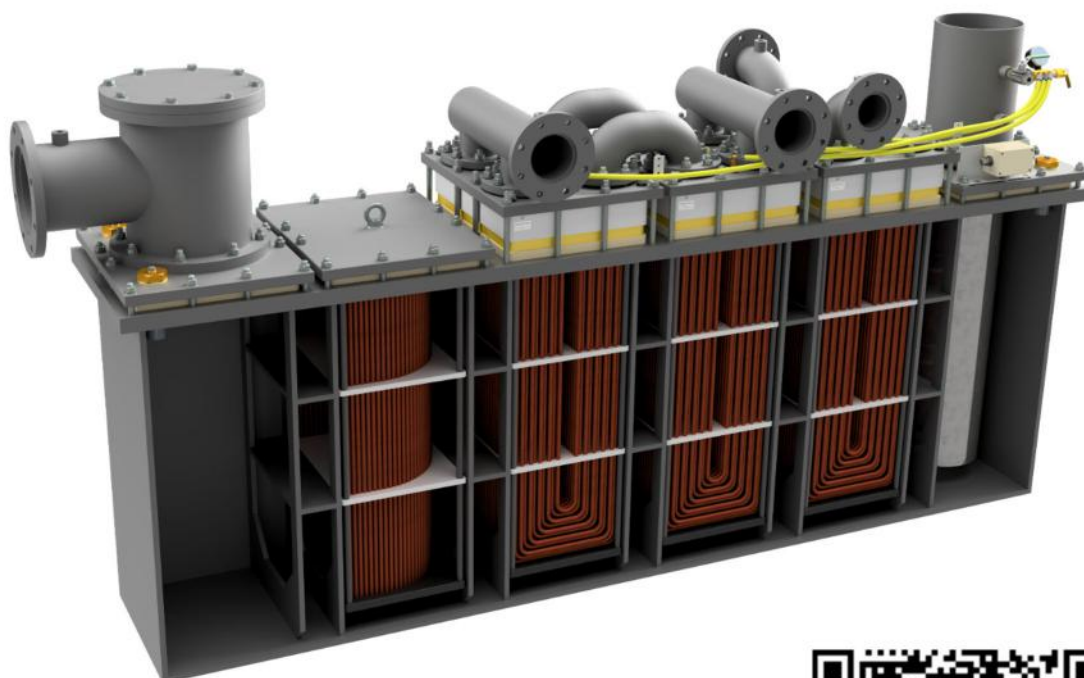

USER MANUAL

RACK COOLER

TYPE: 600C

REVISION: E

REVISION DATE: 04.01.2023



CONTENT

RACK COOLING SYSTEM - GENERAL INFO	4
<i>Purpose</i>	4
<i>Personal safety</i>	4
<i>Warranty</i>	4
START-UP AND COMMISSIONING	5
<i>Ventilation</i>	5
<i>Frequency controller (VFD) for seawater pumps</i>	5
<i>Seawater flow</i>	5
<i>Start-up procedure and running in sequence</i>	5
<i>Insulation Guard</i>	6
<i>Verification</i>	6
<i>Design criteria</i>	6
<i>Maintenance prior to vessel delivery</i>	6
OPERATION	7
<i>Ventilation</i>	7
<i>SW System</i>	8
<i>FW System</i>	8
<i>Insulation guard</i>	9
MAINTENANCE.....	10
<i>Maintenance routines</i>	10
<i>Required maintenance schedule</i>	11
<i>3-way valve – Ventilation kit – Normal running/ Cleaning</i>	14
<i>How to run the flushing cycle:</i>	15
<i>How to run the cleaning cycle:</i>	15
<i>How to empty the Rack case:</i>	15
<i>Lifting instructions</i>	16
DISASSEMBLING/ ASSEMBLING OF RACK BUNDLE.....	17
<i>Seawater (SW)</i>	17
<i>Freshwater (FW)</i>	17
<i>Rack bundle – Assembly direction – 4-pass solution</i>	18
<i>Rack bundle – Assembly direction – 6-pass solution</i>	19

<i>Re-assembling the Rack bundle</i>	20
<i>Cleaning procedure</i>	21
<i>Cleaning process performed onboard or quayside with environmentally friendly liquids</i>	22
<i>Torques</i>	24
<i>Recommended Spare parts – Rack 500S</i>	26
FAULT FINDING AND TROUBLE SHOOTING	29
<i>Rack insulation guard</i>	29
<i>Ventilation kit</i>	29
<i>Cooling</i>	29
<i>Leakages</i>	30
How to check internal leakage in Rack bundle	31
How to plug a broken tube on a Rack bundle	32
PART LIST & ILLUSTRATIONS	33
Top plate for seawater inlet.....	34
Top plate for seawater outlet	35
Blind plate/ Top plate for Protection unit	36
Top plate for Rack bundle	37
Rack bundle	39
Ventilation kit and hoses	40
Protection unit (Option).....	41
Filter unit (Option)	42
HOW TO ORDER SPARE PARTS	43
ADDITIONAL INFORMATION	43

RACK COOLING SYSTEM - GENERAL INFO

Purpose

Hydroniq has produced this manual to provide information for all users of the cooler equipment. This includes information about the cooler's construction and operation, as well as basic information regarding inspection and maintenance.

It is important that operators familiarize themselves with the contents of this user manual to ensure that use and maintenance work are carried out in the correct and safe manner.

The maintenance intervals are based on experience and may vary depending on the cooler's operational parameters.

The supplier accepts no responsibility for damage resulting from careless operation or inadequate maintenance. Keep the cooler in good mechanical condition and remember that preventive maintenance of the equipment reduces the danger of damage and unnecessary operational interruptions.

Hydroniq reserves the right to modify details without prior warning.

Check our web page: www.hydroniq.no for the latest version of this User manual.

Personal safety

Please make yourself familiar with the content in this user manual before operating the cooler.

It is the responsibility of the user to ensure that appropriate controls and precautions are identified and applied in relation to the work envisaged by this document in accordance with relevant statutory, legal and industry requirements to protect the health and safety of the persons undertaking the work.

All operation and service of the cooler is to be carried out by personnel who are familiar with the contents of this manual.

Unauthorized changes or modification of the cooler may result in a safety hazard and is not permitted.

Warranty

Please note that the warranty will be void if the equipment is misused or not handled in accordance with prescribed operating and service standards.

Failure to follow these operating guidelines and principles, or unauthorized changes or modification of the cooler and its components will void the warranty.

The Hydroniq Rack coolers has a limited warranty that is valid only with use of original spare parts purchased from Hydroniq Coolers AS.

Hydroniq RACK cooler is a module-based system, built up by several U-bundles. Since it can be difficult to change a broken tube in a U-bundle, Hydroniq Coolers always adds an extra 3% cooling surface in the capacity calculations, in case of broken tubes during production, installation or start-up. The extra margin in the calculation, and extra tubes installed, will allow for plugging several tubes in service. With up to 2% plugged tubes in a RACK-bundle, Hydroniq Coolers guarantees a 100% cooling capacity as designed and according to design criteria, and therefore consider the bundle as a full worthy product.

START-UP AND COMMISSIONING

Procedure to be used at start-up and commissioning of a new system and after replacement and start-up of new/overhauled bundles.

Ventilation

Make sure that piping system is properly ventilated and without any "air pockets" in the seawater pipes.

Make sure that the Rack cases are properly ventilated by use of the Rack ventilation kit. Also make sure there is no air in the seawater outlet pipe.

Frequency controller (VFD) for seawater pumps

Ensure regulation setting of the VFD. Verify that % operation is corresponding to frequency and corresponding pump capacity from the pump specification/curve.

Seawater flow

Verify and log correlation between pump speed and flow. Check VFD operation e.g. 25% is corresponding to actual seawater flow of 25%. To be verified by clamp on flowmeter and documented.

Seawater circulation (cold side) shall always be in operation before hot fluid circulation.

Hydroniq can be of assistance for a check of seawater flow, if needed.

Start-up procedure and running in sequence

Please note the following requirements:

First 3 weeks: max 50% flow

Note!

This running in sequences is very important to assure the oxide layer (protective layer) on the tubes will be formed.

Insulation Guard

Confirm installation and operation of insulation guard, and no active alarms.

Verification

Verify water pressure at pump inlet with pump in standstill condition and valves open. This to be verified after completed ventilation procedure.

Log seawater inlet and outlet temperature.

Log freshwater temperature.

If several Rack systems installed, verify, and monitor difference between systems. Ensure same operation patten between both systems.

Look for abnormal vibrations and/or noise.

Design criteria

Design pressure inside tubes: 6 Bar

Design temperature: 0-95°C

Max. flow according to individual project design calculation.

Caution!

During stand still for more than 7 days, the Rack case must be drained for seawater.

If this is not possible, run seawater through the Rack system at least every 7 days (approx. 10 min, 50 % flow).

Maintenance prior to vessel delivery

If the Rack systems is going to be in continuous operation prior to vessel delivery, it is important that the maintenance routines for the product set forward in the User Manual is followed. If water conditions are unfavourable in terms of polluted or dirty water, maintenance intervals need to be adjusted accordingly.

User Manual can also be found on www.hydroniq.no.

OPERATION

Ventilation

Install the ventilation kit and ventilation hoses according to this picture.

The function of this kit is to remove all air pockets from the Rack case.

For more information, see chapter “3-way valve – Ventilation kit – Normal running/ Cleaning”.

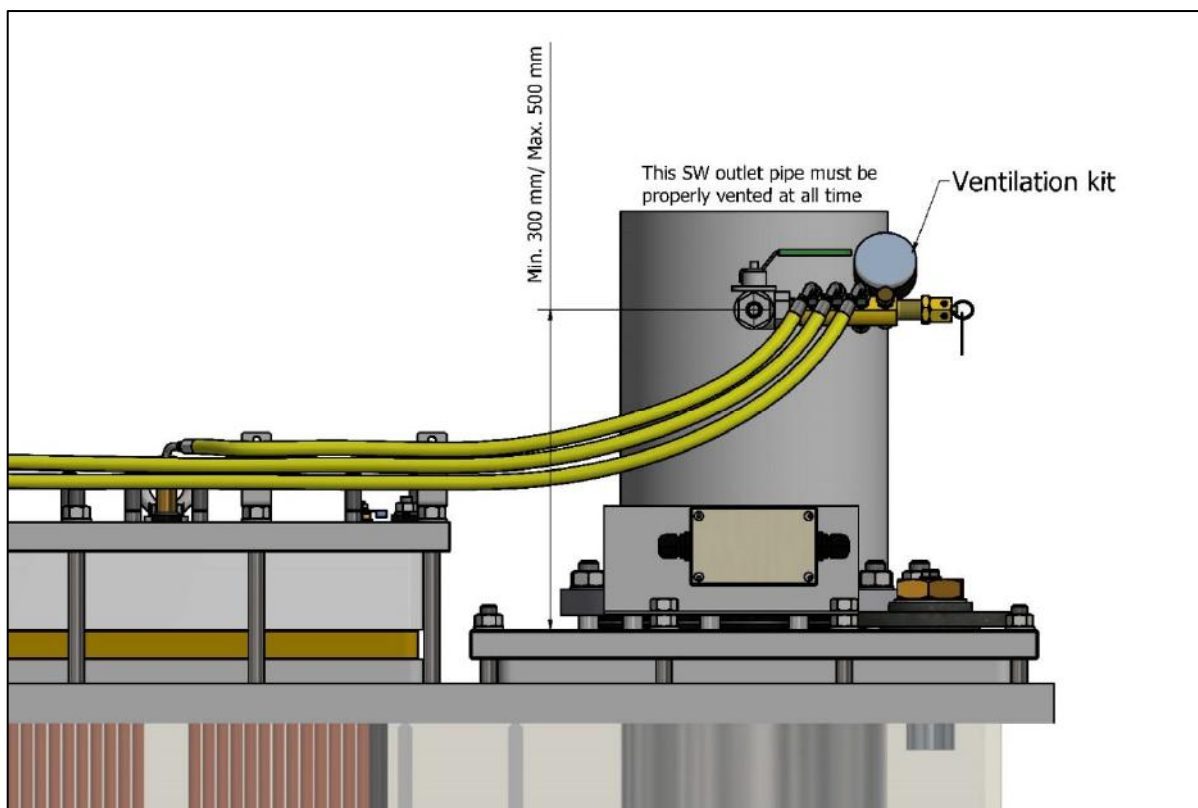

Caution!

It is very important that the Rack ventilation kit is installed correctly to prevent air in seawater. Air in seawater will prevent the creation and maintenance of a good oxide layer, and this can cause serious corrosion problems.

In addition, the air can cause vibrations that will make the tubes less resistance of corrosion, and in some cases, it can lead to fatigue.

It is also important that the seawater piping is proper ventilated.

SW System

Seawater flow shall never exceed the max. flow according to individual project design calculation. For the actual design data sheet(s) for your project; Check the Installation manual, Part 4, Appendices, Appendix 1, Chapter 4.1.8.

If frequency controller (VFD) for seawater pumps is installed, ensure regulation setting of the VFD. Verify that % operation is corresponding to frequency and corresponding pump capacity from the pump specification/curve.

For example: Is 100% equal 60 Hz and thereby 100% pump capacity? (in some cases, VFD is set to 75% equal 60 Hz and thereby 100% pump capacity). This is important information and needs to be confirmed and documented.

VFD ramping up sequence. Ensure that the pump speed is ramping up and not starting at 100% for later ramping down to for example 25%. Repeated sudden starts at 100% is not acceptable.

Check pump operation if multiple pumps are installed. Verify different operation modes. If operation mode allows for 2 pumps operating in parallel, seawater flow shall never, at any time, exceed maximum design level.

Hydroniq can be of assistance for verification test, if needed.

Seawater circulation (cold side) shall always be in operation before hot fluid circulation.

FW System

All additives must be compatible with Cu/ Ni tubes.

If there are particles bigger than 5 mm in the freshwater, a filter must be mounted before the Rack bundle.

The in-/ outlet valves must be close to but located at the outside of the Rack bundle top plate.

All FW piping's and blind flanges on the Rack bundles must have the possibility to be ventilated.

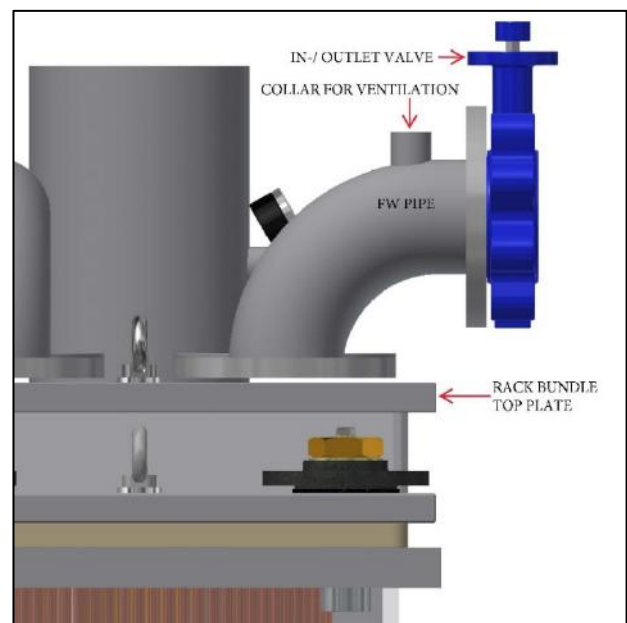

Insulation guard

Program description

The PLC is programmed to monitor the Hydroniq Rack Cooler. Each bundle is separately monitored and has an individual error message. Error messages are displayed in the control panel. The monitor runs a test run once a day if auto is activated and a manual test run can be initiated by pressing F1. Press F4 for light in the display.

PLC Configurations

Clock settings:

1. Open the Insulation cabinet door
2. Find the Siemens Logo display
3. Press "arrow down"
4. Then "ESC"
5. Choose "Setup" and press "OK/Enter"
6. Choose "Clock" and press "OK/ Enter"
7. Choose "Set clock" and press "OK/ Enter"
8. Use the arrows to set the correct time and date
9. Press "ESC"



Number of bundles:

Change the number of bundles the PLC can monitor (from 1 to 7 bundles):

1. Press "arrow down"
2. Then "ESC"
3. Choose "Program" and "Enter"
4. Set Param press "Enter"
5. Scroll down to you see "NRofBund" press "Enter"
6. In the field "On", press "Enter", then "arrow right" to the last number.
7. Choose the number of Bundles that your Rack system has by pressing the "arrow up or down".
8. Press "Enter"
9. Press "Esc" four times, and "arrow up"

User description:

To start testing the Rack for insulation faults:

1. Press F1 and the display will show "TESTING"
2. The PLC is testing each bundle on the Rack.
3. Wait for the test to finish. If the PLC finds any faults it will display error message in the front display, and it flashes red.
4. To toggle Auto testing, press F2.
5. When the display shows "Auto is on" the PLC test once every TL value on block 22 (default 12Hours)

MAINTENANCE

Maintenance routines

The following is a guideline for a normal maintenance schedule. However, the Rack Coolers operating conditions vary widely from installation to installation, and it is therefore important to adapt the maintenance schedule to the experience of the individual operator.

Note!

Sacrificing anodes must be inspected at least every third month until rate of consumption is established.

Rate of anode consumption is dependent of quality of fluid, pipe system and machinery connected to Hydroniq Rack cooler.

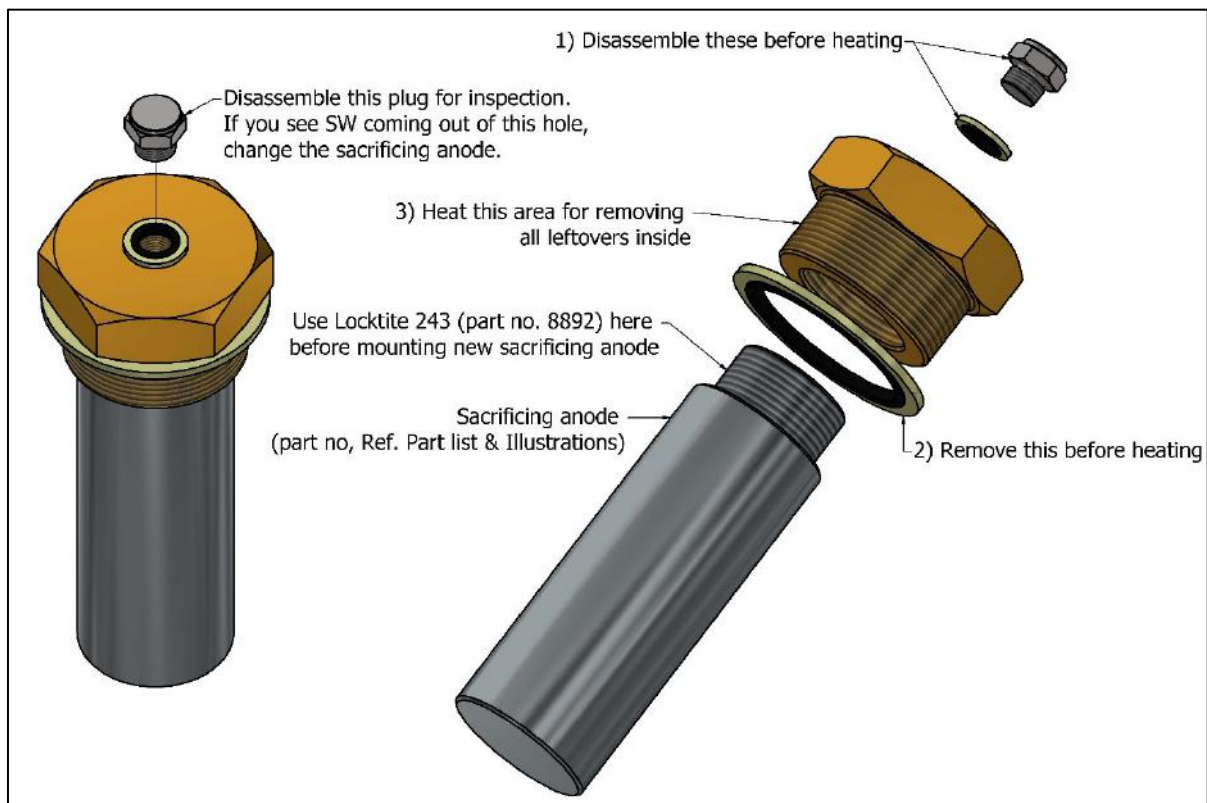

Note!

Damage caused by insufficient anodic protection is not covered by the warranty. Hydroniq Rack cooler may need cleaning at regular intervals based on service experience.

Required maintenance schedule

No.	Task	Weekly	1 month	3 months	6 months	12 months	30 months	60 months	120 months
1	Filter-unit (if applicable)	X							
2	Flushing (Max. 10 min.)		X						
3	Visual inspection		X						
4	Check Insulation guard		X						
5	Sacrificing anode inspection			X					
6	Cleaning cycles (Max. 30 min.)			X					
7	Check the nuts			X					
8	Protection unit inspection (if applicable)				X				
9	Replace sacrificing anode					X			
10	Sacrificing T-piece inspection (if applicable)					X			
11	Replace the sacrificing T-piece at filter unit (if applicable)						X		
12	Replace ventilation kit						X		
13	Replace ventilation hoses and parts						X		
14	Main class overhaul							X	
15	Replacement of all bundles and parts								X

- 1) See next page if you have installed this filter unit at seawater inlet position.
- 2) Run the flushing cycles once a month. (See page 15 for instruction).
- 3) Check for leakages at the ventilation kits and around each Rack systems.
- 4) Press F1 on the insulation guard for a manual test. (Press F4 for light at the display).
- 5) See page 10 for instructions.
- 6) See page 15 for instructions.
- 7) Re-tighten all nuts with the correct torque (see torques at page 24).
- 8) Before inspection, empty the Rack case. (See page 15 for instructions). Remove the protection unit top plate. Check inside the protection unit for dirt.

- 9) Replace the sacrificing anodes at least once a year.
- 10) Remove the 8 pc. M16 nuts on the amplifier for the filter unit and lift up the filter unit by the lifting eye. Check inside the T-piece. (If applicable).
- 11) Replace the sacrificing T-piece at filter unit (if applicable).
- 12) Replace the ventilation kit (part no. 8666).
- 13) Replace the ventilation hoses and parts.
- 14) Follow the Hydroniq overhaul procedure.
- 15) Follow the Hydroniq procedure.

No. 1 (if applicable)

It is recommended to lift up the floater (part no. 8738-08) by the manual handle (part no. 8734) once a week (when SW pump is running at low speed).

Normal operation

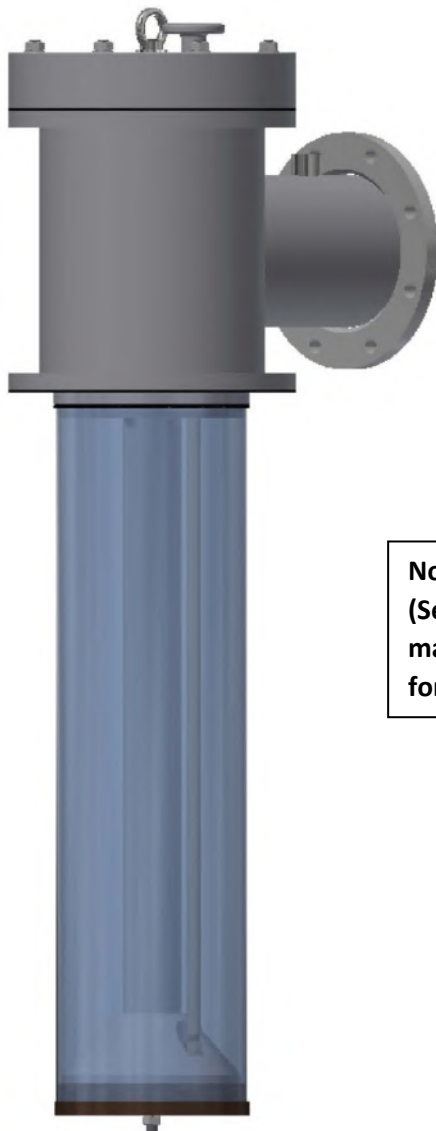

Cleaning the filter

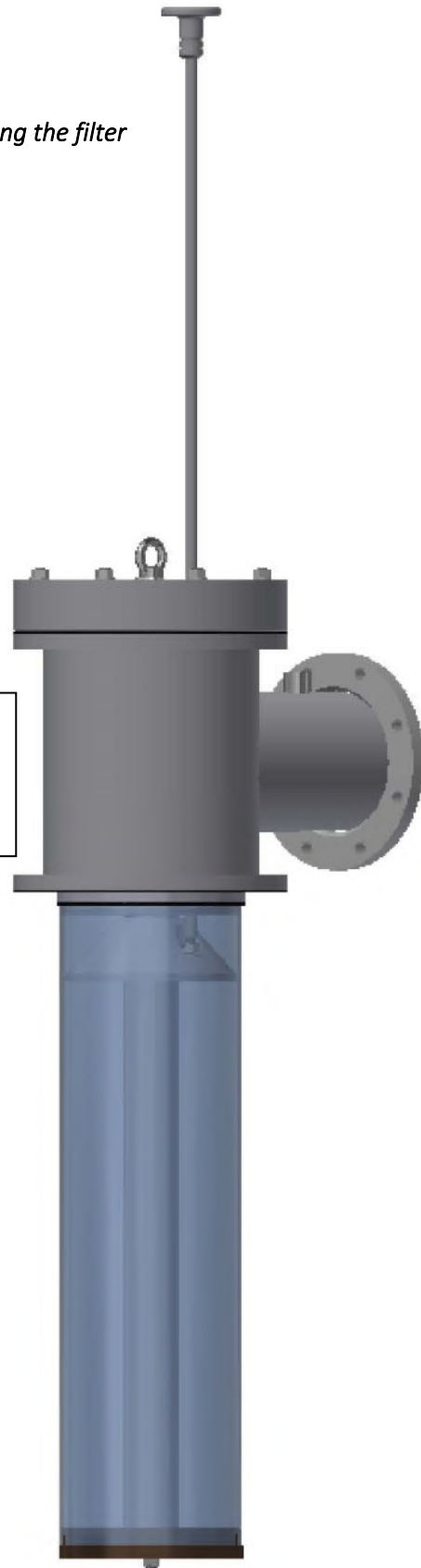

**Note! Sacrificing T-piece.
(See required
maintenance schedule
for this T-piece)**

3-way valve – Ventilation kit – Normal running/ Cleaning

Normal running

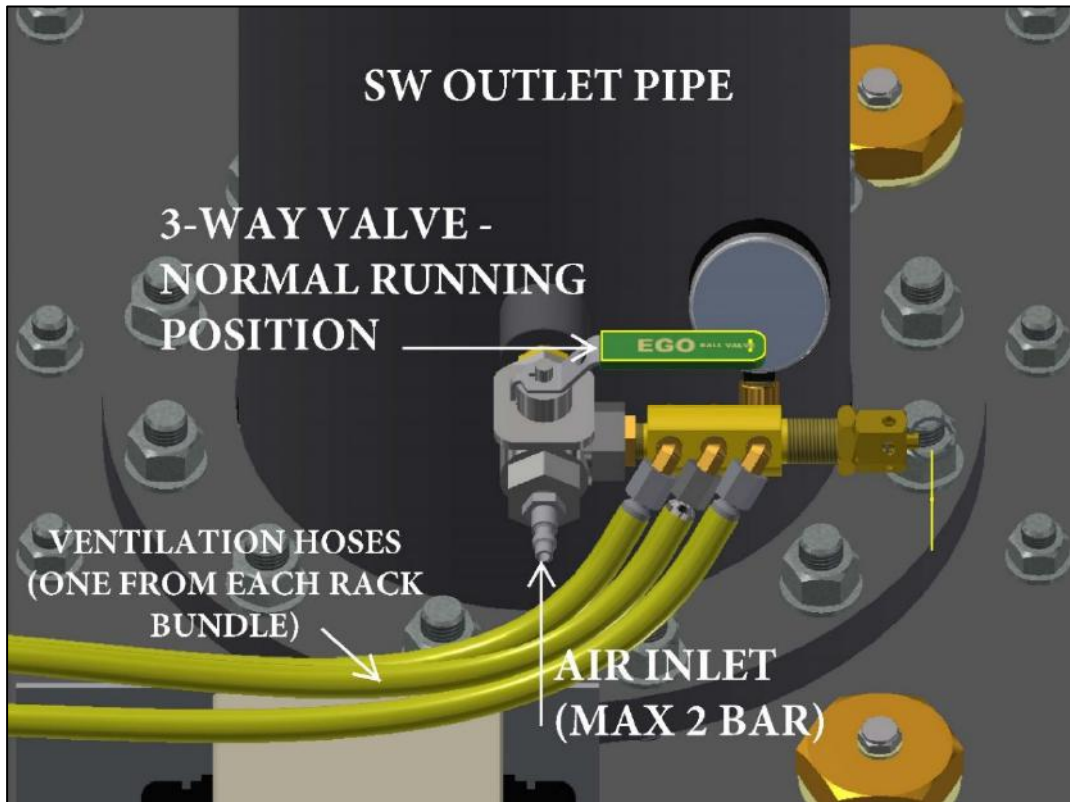

Cleaning/ Emptying

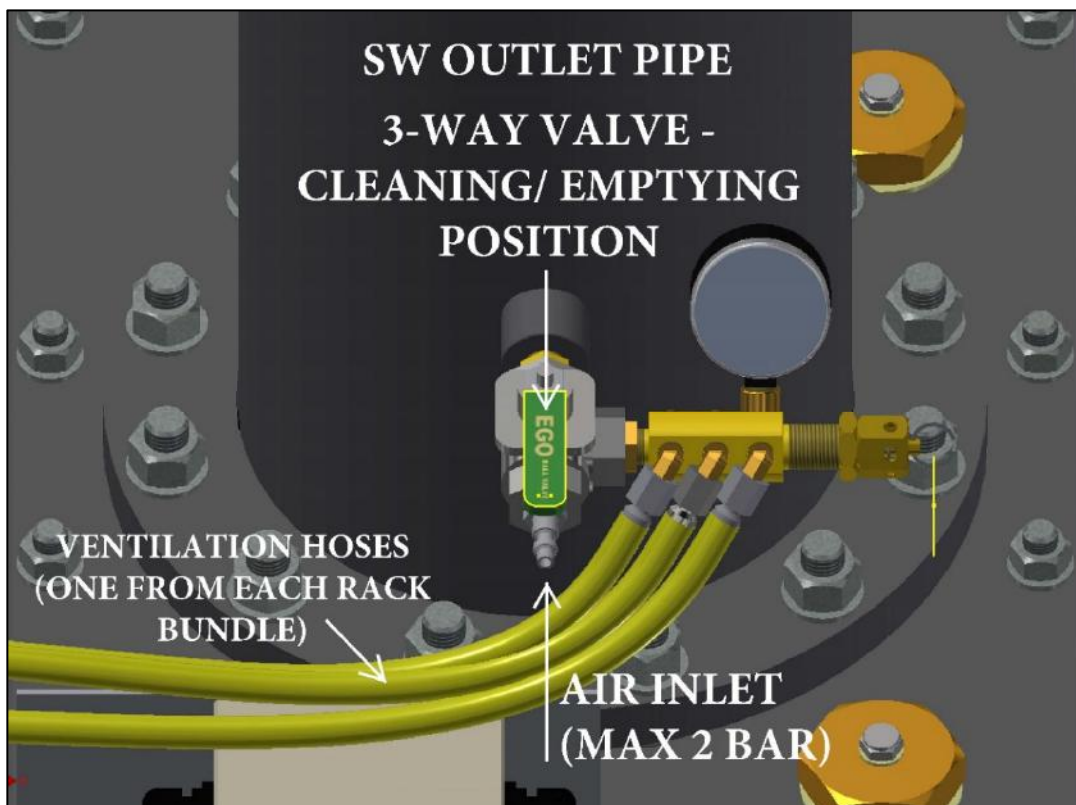

How to run the flushing cycle:

1. Run seawater pump at max. calculated flow (Check the Installation manual, Part 4, Appendices, Appendix 1, Chapter 4.1.8).

How to run the cleaning cycle:

1. Connect air to the ventilation kit (max. 2 bar)
2. Run seawater pump at max. calculated flow (Check the Installation manual, Part 4, Appendices, Appendix 1, Chapter 4.1.8).
3. Open the 3-way valve at “cleaning” position (see picture on previous page) for max 30 minutes.
4. Disconnect air hose from the 3-way valve
5. Turn the 3-way valve at “Normal running” position (closed) after seawater comes out of the air hose connection.
6. **Make sure that all air has been ventilated from the Rack case.**

How to empty the Rack case:

1. Close the seawater inlet valve
2. Connect air to the ventilation kit (max. 2 bar)
3. Open the 3-way valve at “cleaning” position
4. When the Rack case is empty, close the 3-way valve by turning it to “Normal running” position
5. Close the seawater outlet valve
6. Disconnect air from the ventilation kit
7. To release the air from Rack case, turn the 3-way valve to “Cleaning” position

Warning!

Make sure there is no pressure in Rack case before starting; disassembling the Top plates/ Rack bundles/ Sacrificing anodes.

Ventilation kit



Caution!

The air inlet connection on the ventilation kit should not be blocked. If this is blocked, and the 3-way valve is in cleaning/ flushing position when starting the SW pumps, automatic ventilation of the Rack case will not work, and air will accumulate in the Rack case.

The system is now ready for inspection/ maintenance. Start checking the Rack bundle located nearest SW inlet.

Yearly inspections are recommended in order to establish fouling rate.

Lifting instructions

Warning!

The weight of the Rack bundles must always be checked before attempting to lift, to ensure that the lifting equipment is certified to carry the actual load. The weight of the Rack bundle you will find in the Installation manual, Part 4 – Appendices - Appendix 1 - 4.1.6.

When in need of lifting the Rack bundles, the following instructions must be followed:

- Close the FW in- and outlet valve
- Remove all FW piping from the actual bundle(s)
- Remove the ventilation hose
- Remove the Insulation guard wire at the top plate
- Always lift by the lifting eye located on the Rack bundle top plate
- Always check that the lifting eye is tighten before you start lifting
- Use a certified shackle and strap



DISASSEMBLING/ ASSEMBLING OF RACK BUNDLE

If a Rack bundle must be disassembled for inspection or servicing, it is recommended to work according to following sequence:

Seawater (SW)

- Close the seawater inlet valve.
- Connect air hose at 3-way valve (max. 2 bar)
- Open the 3-way valve at “cleaning” position. This will empty the Rack case for seawater.
- Close the SW outlet valve when all SW is drained. This takes approx. 20-40 min.
- Turn the 3-way valve at “Running” position (closed).
- Disconnect the air hose at 3-way valve.
- Open the 3-way valve at “cleaning” position and evacuate all air thru the 3-way valve.
- Make sure there is no pressure in the system before disassembling the Rack bundle.

Freshwater (FW)

- Close in/ outlet valves.
- Make sure there is no pressure in the FW piping before disassembling the two ¼” BSP plugs at the FW top plate.
- Install the plastic tubes (part no. 8905-P, supplied by Hydroniq) according to below picture.
- Use service air to evacuate the glycol/ freshwater (max 2 bar).



Rack bundle – Assembly direction – 4-pass solution

Distribution frame (1): The sticker and the hole (2) indicate that the piece (3) shall point towards seawater inlet.

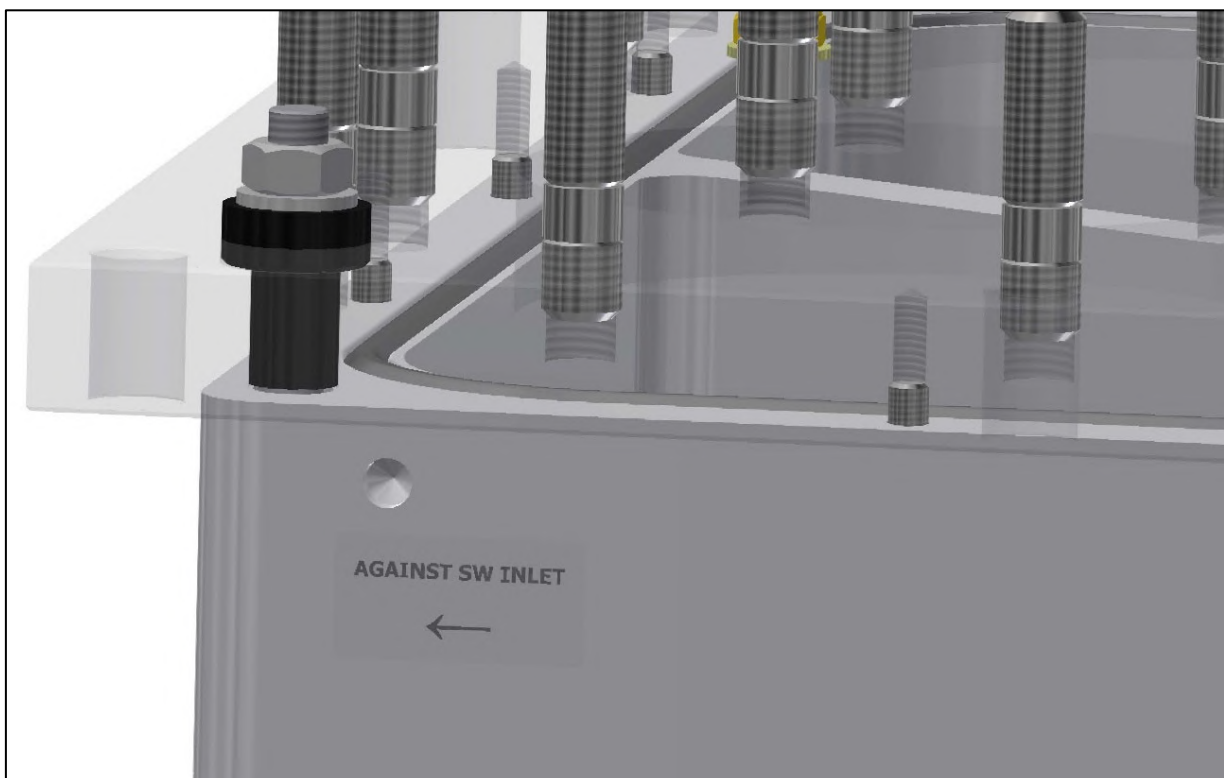
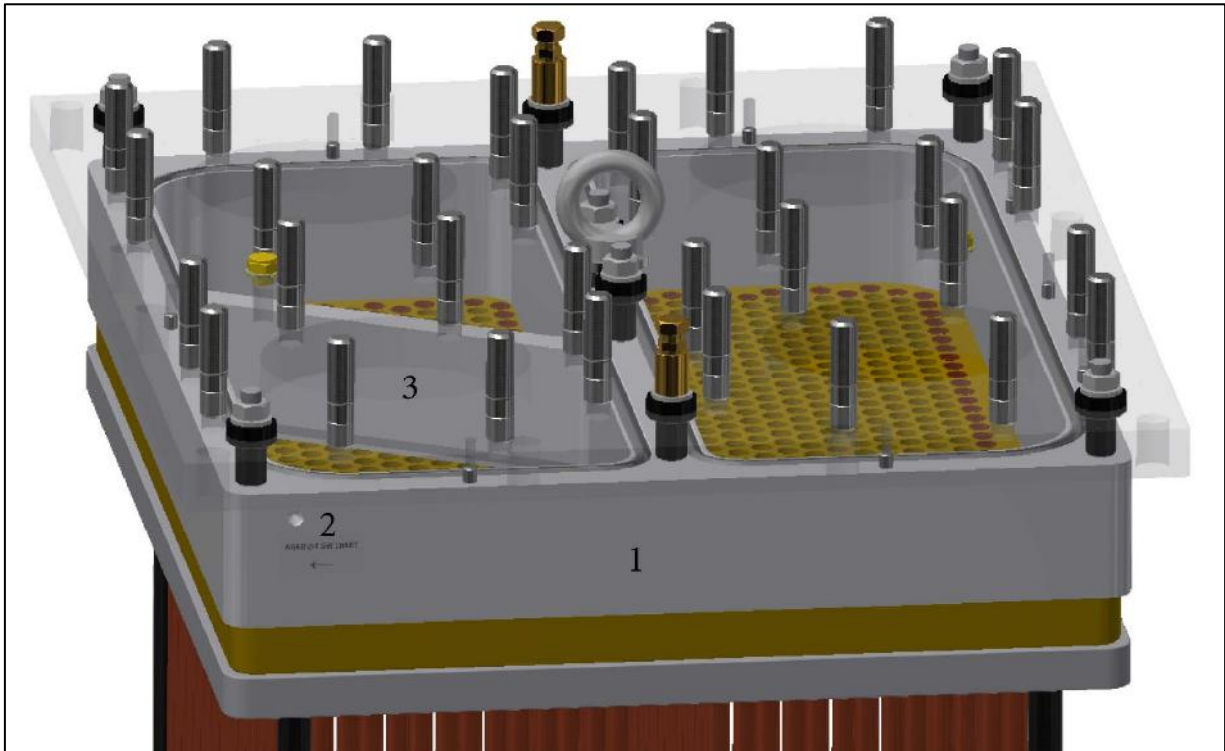

Rack bundle – Assembly direction – 6-pass solution

Distribution frame (1): The sticker (2) indicate that the piece (3) is the side where you must connect the FW inlet connection.

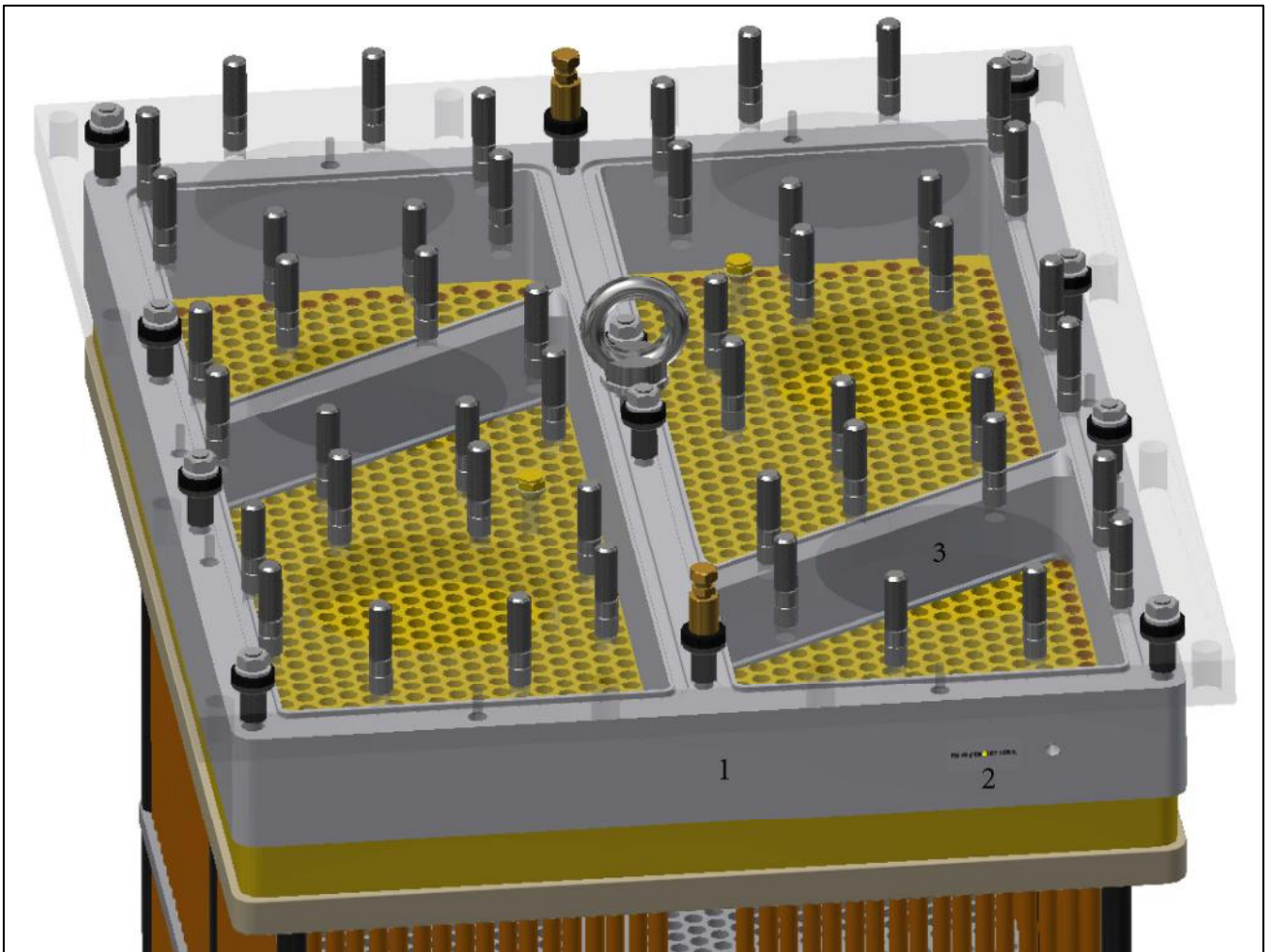

Re-assembling the Rack bundle

- Check that surfaces are clean and unharmed.
- Check that the gaskets are in good shape.
- Always assemble the Rack bundles according to below picture.
- It is not recommended to reuse gaskets, since these may have lost elastic properties due to service temperature of Rack bundle and aging.

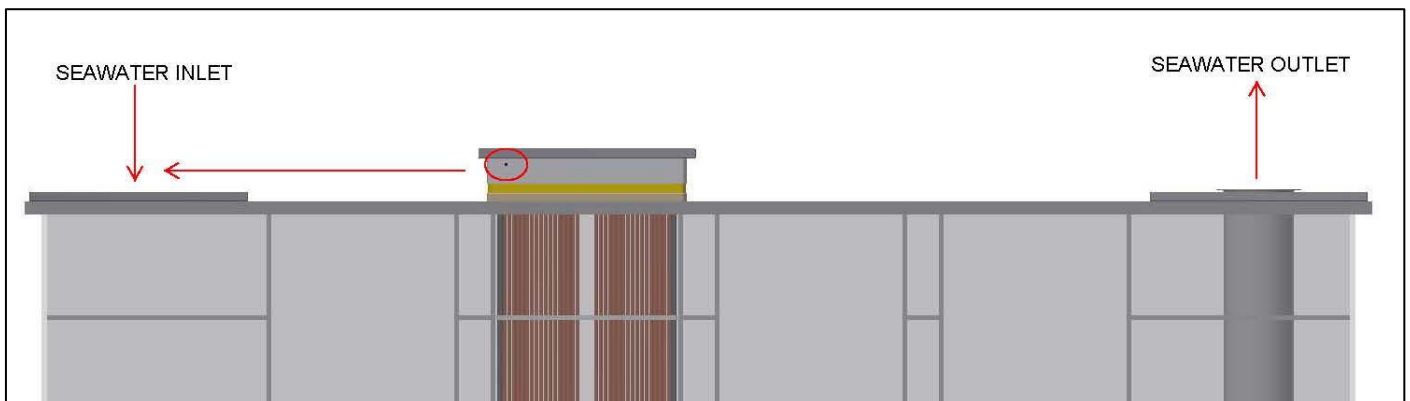

- Tighten the M16 nuts in a cross pattern with a torque of 120 Nm.
- Then tighten the M12 nuts in a cross pattern with a torque of 50 Nm.

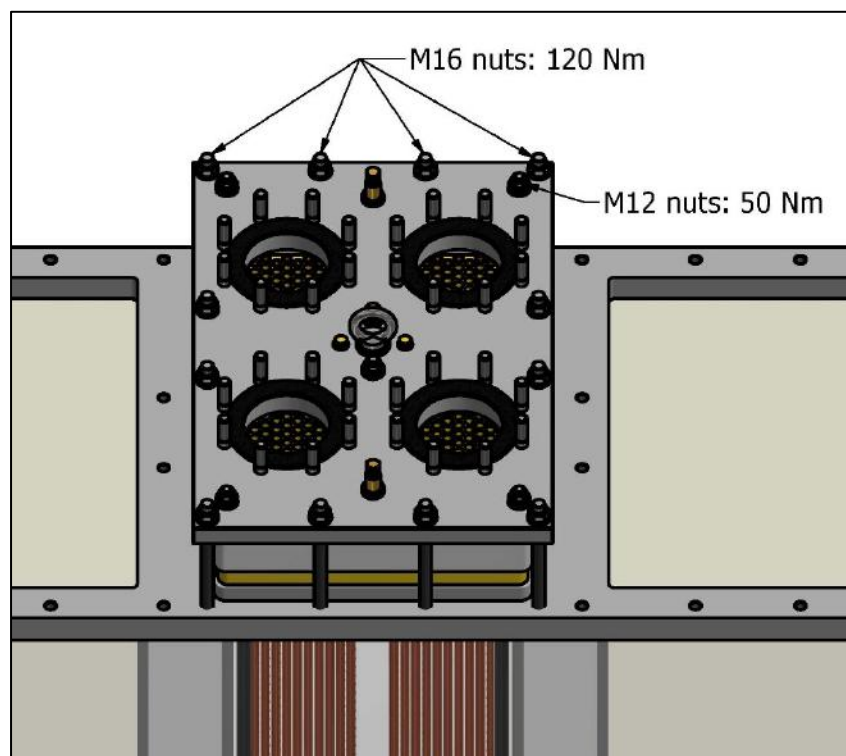

Note!

It is recommended to check the nuts after 3 months.

Cleaning procedure

Start by using high pressure washer cleaning the outside of the bundle. This can be done on location or dockside.

Flushing with chemical detergents for cleaning must be followed by thorough procedure for removal of detergents.

Make sure to use only chemicals compatible with material in Hydroniq Rack bundle. Mechanical brushing of tubes using metal brushes must be done with care in order not to harm tubes.

We recommend that you use a mild detergent without hydrochloric acid when cleaning the Rack bundle. We have used MULTI SCALE (20% Multi Scale and 80% water) with very good result on our Rack bundle.

Use this only if needed, because of tear and wear on the Cu/Ni pipes.

See example of a cleaning process with Multi Scale on the next two pages.

Hydroniq part no. Multi Scale:

20 litres: 8996

1000 litres: 8995

Cleaning process performed onboard or quayside with environmentally friendly liquids

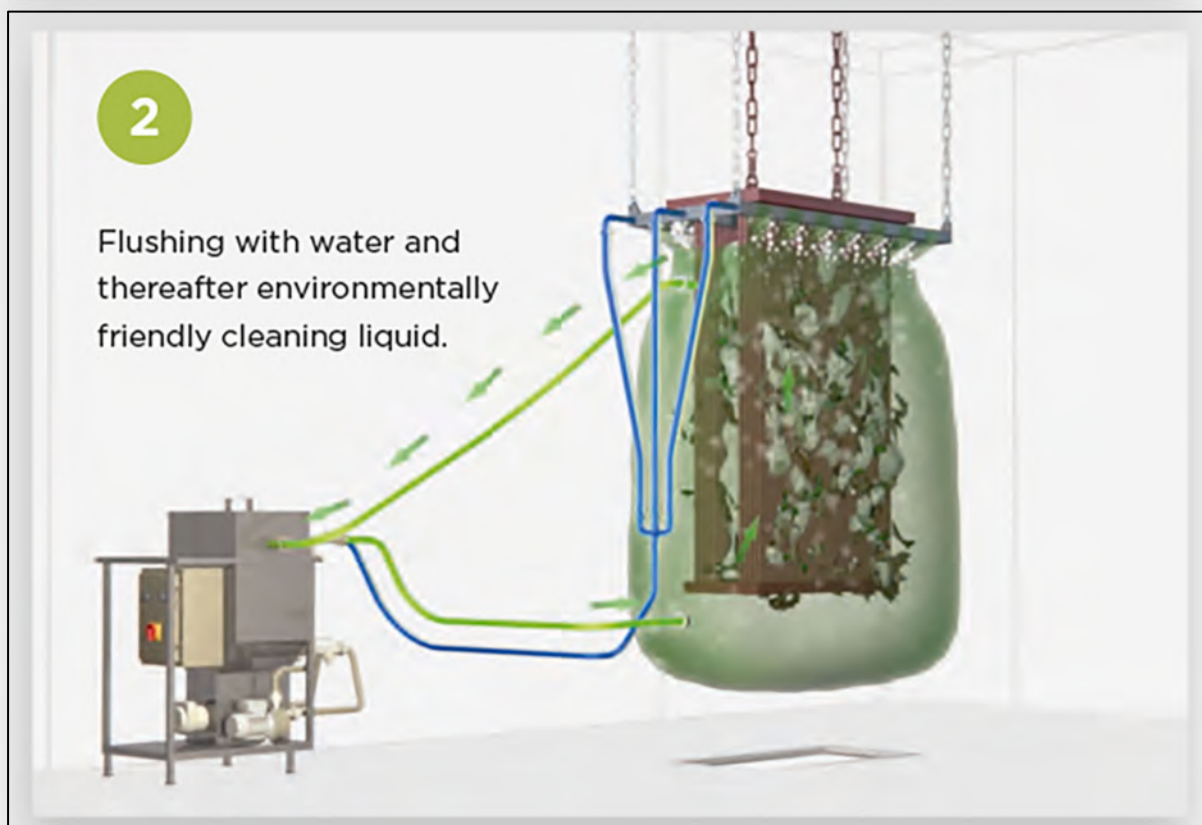
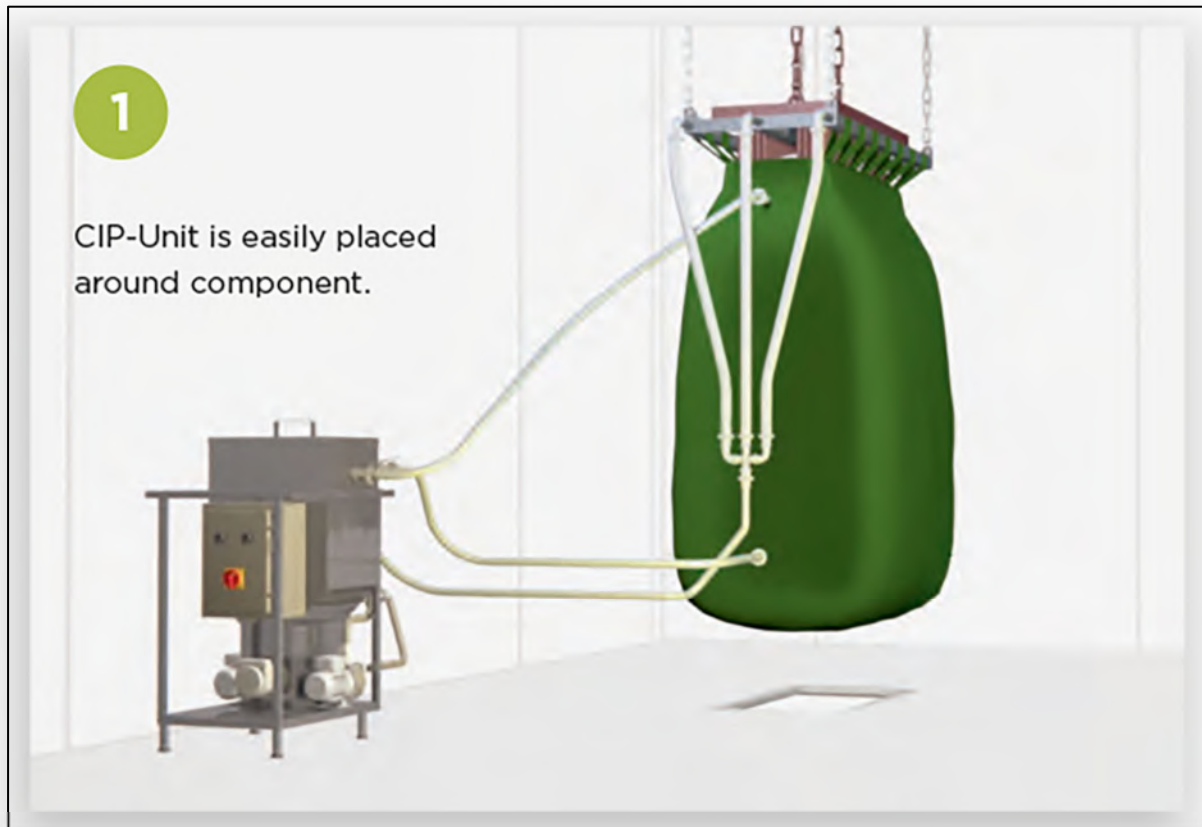

3

Highly efficient cleaning without any damage or danger to the component.

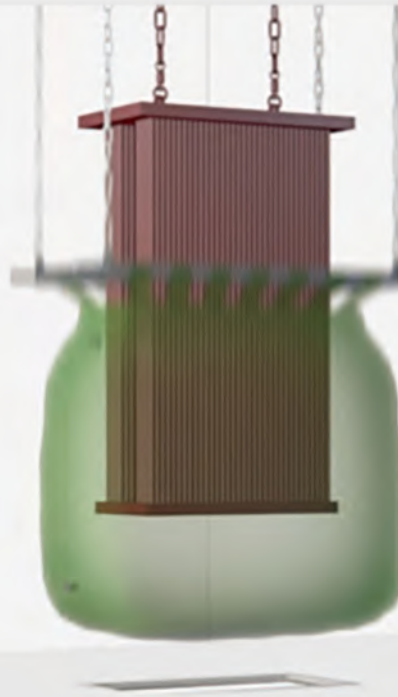

4

Clean component.



Torques

- | | |
|--|--------|
| 1. M12 nuts at the Rack bundle top plate: | 50 Nm |
| 2. M16 nuts for the zinc anode flanges: | 80 Nm |
| 3. M16 nuts at the Rack bundle top plate: | 120 Nm |
| 4. M16 nuts at the SW in-/ outlet plate: | 120 Nm |
| 5. M16 nuts for the FW pipe: | 120 Nm |
| 6. M16 nuts for the blind flanges: | 120 Nm |
| 7. M16 nuts at the spare top plate: | 120 Nm |
| 8. M16 nuts at the filter unit (option): | 120 Nm |
| 9. M16 nuts at the Protection unit (option): | 120 Nm |

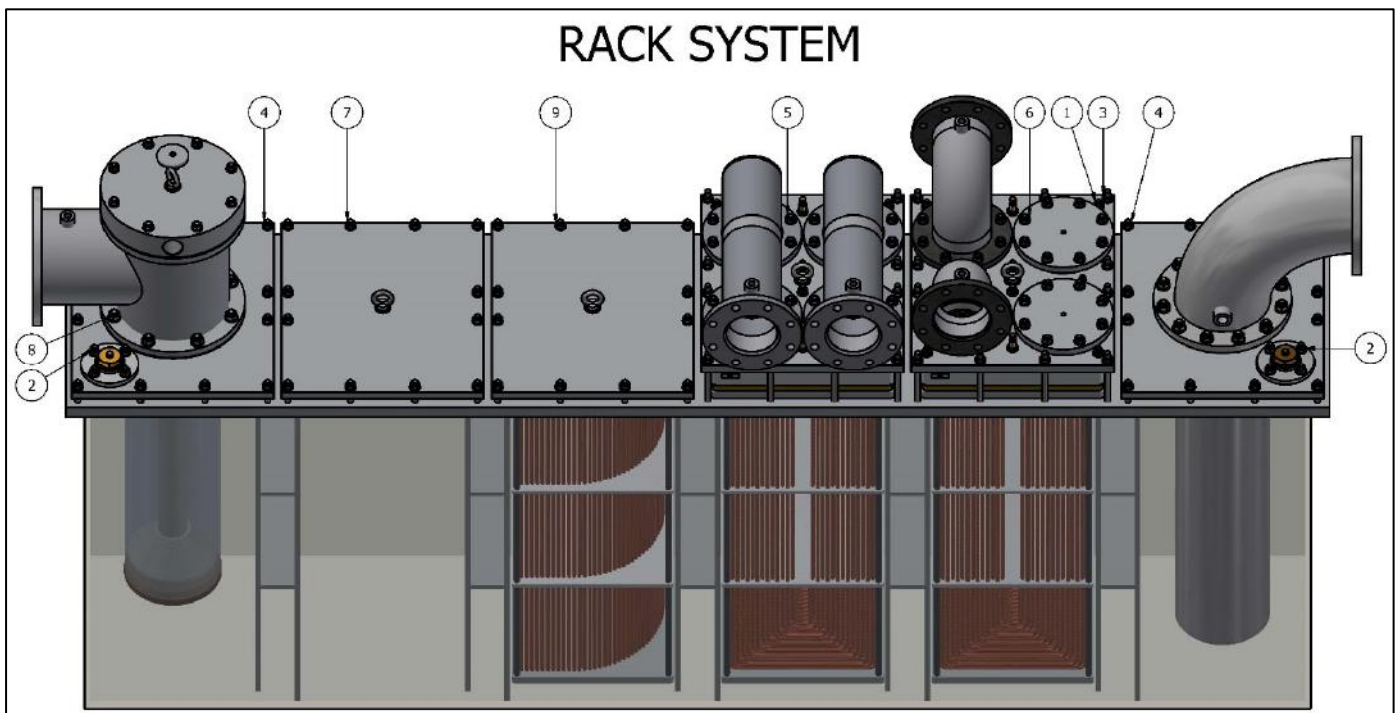

Note!

Ensure that the needed service space above all the compartments of the Rack system is maintained free of obstacles and other installations to secure the possibility of lifting the Rack bundles for inspection and service.

If installations above the Rack systems cannot be avoided, such installation must be made easily removable.

RECOMMENDED PLACEMENT OF LIFTING BEAM

(Example: Rack system - 600S x 1200)

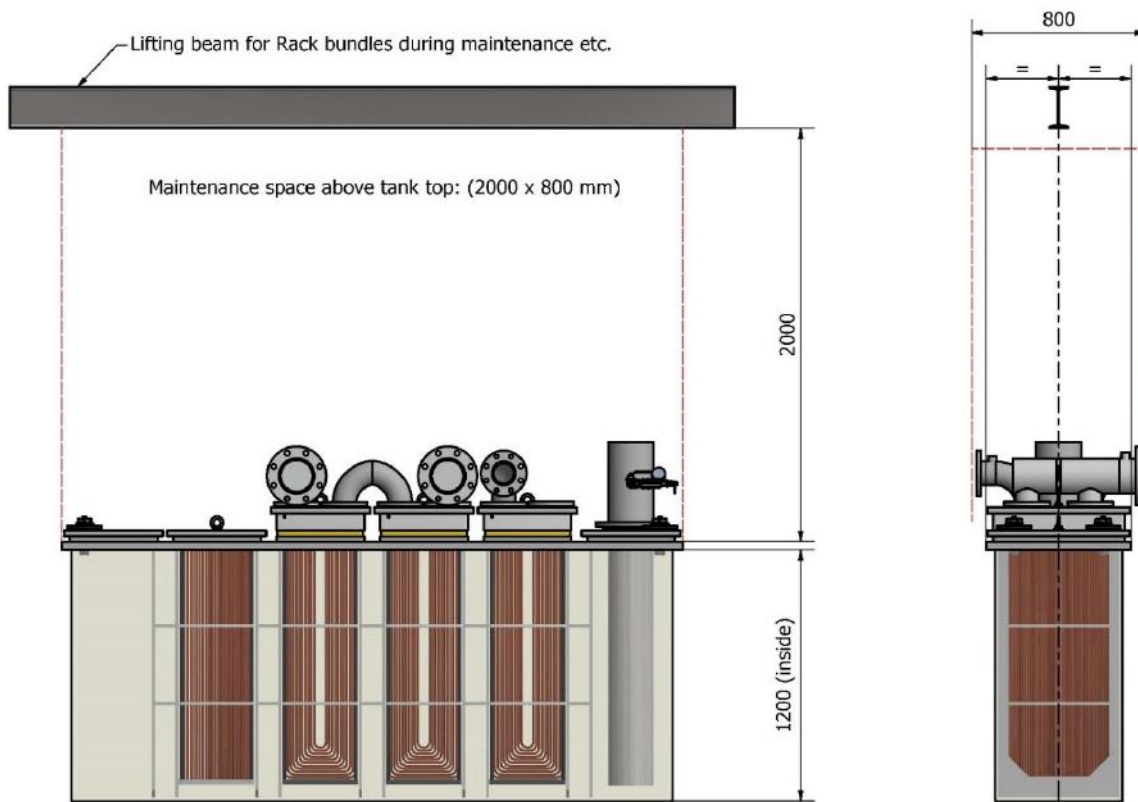









NOTE!

To find out the maintenance space above the Rack system, use the length inside the Rack case and add 800 mm.
800 mm = Approx. the crane and chain distance.

Recommended Spare parts – Rack 600C

Part name	Sketch	Dimension (mm)	No.	Part no.
FW top plate		690 x 480	0	8831C
Distribution frame		634 x 424	1	8835C
Gasket FW (distribution frame)		575 x 173	4	8843C
Bolt for distribution frame		M8 x 75	10	8646-01
Gasket gland Tank top		634 x 424	2	8839C
Gasket SW (gasket gland)		603 x 399	4	8844C
Gasket for FW in-/outlet connections		115 x 162 x 5	4	8866
Zinc complete		2" BSP	0	8897
Zinc anode		ø50 mm	4	8898

Part name	Sketch	Dimension (mm)	No.	Part no.
Seal gasket for zinc		2" BSP	4	8899
Ventilation kit		1/2" BSP	2	8666
Ventilation hose		1/4" BSP		8849-****
Nipple for ventilation hoses		1/4" BSP	0	8849-05
Cap nut with gasket		1/4" BSP	0	8849-06
Ventilation bolt		M12	2	8656
Gasket for ventilation bolt		6 x 11 x 1	2	3925
Nut for ventilation bolt		1/4" BSP/ M12	2	8660

**** = Length of the flexible hose(s)

Part name	Sketch	Dimension (mm)	No.	Part no.
Guide for M12 bolts		Ø36/ Ø30	8	8845
M12 bolt on top of bundle		M12 x 135	6	8644-01
Nut for M12 bolts		M12	6	8642
Washer for M12 bolt		Ø13	6	8649
Plug FW top plate		1/4" BSP	2	4294
Bonded seal		1/4"	2	8946
Brass plug		Ø12,7 mm	20	4686
Rack element		600C x 800 600C x 1000 600C x 1200 600C x 1500	0 0 0 0	894C 885C 884C 881C

FAULT FINDING AND TROUBLE SHOOTING

Rack insulation guard

Fault	Check list
Faulty Insulation System	Check that the parameters are correctly set for the numbers of bundles. (See chapter "Operation – Insulation guard" for settings)
	Check all cables, and that each Rack bundle is in generally good condition
	Open the Rack system and inspect the seawater side
	Check the sacrificing anodes
	Check each stud bolt between top plate and Rack bundle for dirt
	Check for dirt between the Rack bundles and Rack case top plate

Ventilation kit

Fault	Check list
Safety valve blows during emptying the Rack case	Check if flexible hoses are blocked internally or externally
	Reduce air pressure into the 3-way valve
Safety valve leakage during operation	Change the ventilation kit

Cooling

Fault	Check list
Low water flow in SW system	Check filters, pumps and valves
Dirty protection unit/ filter unit	Clean protection unit/ filter unit
Wrongly installed element	Check that the elements are mounted correctly. The small marking on the distribution frame shall always point towards seawater inlet. (See chapter "Rack bundle – Assembly direction").
Dirty element	Clean the element
Low water flow in FW system	Check for obstructions on top of the Rack bundle

Leakages

Fault	Check list
Loosing FW	Check if Rack system is leaking by closing the in- / outlet valves and see if you stop losing FW
	Check which Rack bundle is leaking if possible, by closing the in- / outlet valves and see if you stop losing FW
	Check for leakages around the Rack system
	Pressure test the Rack system. (See chapter "How to check internal leakage in Rack cooler" on next page)
Increased salinity in FW	(See chapter "How to check internal leakage in Rack cooler" on next page)
SW leakage external	Locate the leakage by visual inspection
Leakage around the gasket gland against the tank top	Check for loose items
	Check the torque of the nuts around the Rack bundle
	Lift the Rack bundle to check the gaskets, gasket gland and gasket surfaces
Leakage around the ventilation kit	Check the kit for corrosion
	Check for loose part on the kit
Leakage around the ventilation bolt(s)	Check the gasket (part no. 3925) inside the ventilation nut (part no. 8660)
	If the ventilation bolt is loose, use thread sealant

How to check internal leakage in Rack bundle

- Close SW inlet.
- Open the 3-way air valve at the ventilation kit and insert air into the Rack case. SW outlet must be open. Do not exceed 2 bar. You will now empty the Rack case for SW.

Normal running

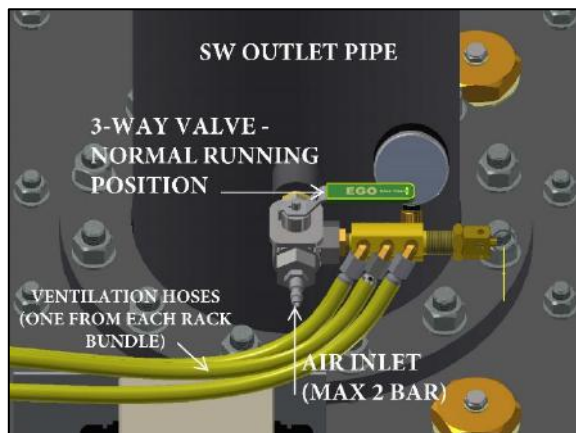

Cleaning/ Empty the Rack case for SW

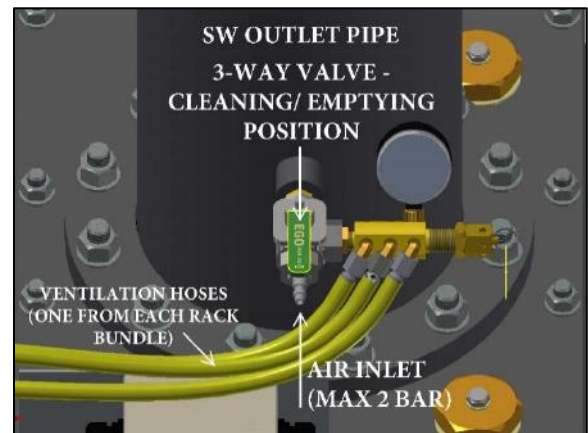

- When Rack case is empty, close SW outlet valve and the air inlet valve on the ventilation kit.
- Close FW valves inlet and outlet.
- If you want to avoid any spill of FW/ glycol, use the FW evacuation kit (part no. 8905-P) to evacuate the FW/ glycol down to the top of the top plate. (See how to connect this kit in the User manual).
- Remove all the FW piping/ Blind flanges.
- Open the air inlet valve again. This is to increase the pressure inside the Rack case (Not more than 2 Bar)
- If there are broken internal pipes, bubbles will appear, and you will find the leakage.



- This can be repaired with a plug, Hydroniq part no. 4686.
- Reduce pressure inside the Rack case by opening the SW outlet valve, or by disconnect the air inlet hose on the ventilation kit.
- To evacuate all air inside the Rack case, leave 3-way valve open (at cleaning/ emptying position) until there comes water out of the air inlet hose connection.
- Turn the 3-way valve back to normal running position again.
- The Rack system is now ventilated, and you can open all valves again.

How to plug a broken tube on a Rack bundle

- Locate the leakage
- Find the brass plug (See inside the Insulation guard)

Brass plug (Part no. 4686)



Plugs inside Insulation guard



- Carefully hit the plug with a hammer into the tube. Remember this is a U-tube cooler, so you need also to plug the other side of the tube. Do not use force.

Do it like this:



Hydroniq RACK cooler is a module-based system, built up by several U-bundles. Since it can be difficult to change a broken tube in a U-bundle, Hydroniq Coolers always adds an extra 1% cooling surface in the capacity calculations, in case of broken tubes during production, installation or start-up. The extra margin in the calculation, and extra tubes installed, will allow for plugging several tubes in service. With up to 1% plugged tubes in a RACK-bundle, Hydroniq Coolers guarantees a 100% cooling capacity as designed and according to design criteria, and therefore consider the bundle as a full worthy product.

HOW TO ORDER SPARE PARTS:

See the chapter “How to order spare parts” at the end of this manual.

PART LIST & ILLUSTRATIONS

Top plate for seawater inlet

Hydroniq Rack coolers have a seawater inlet top plate that can be fitted to different sizes and standards.

As standard there are two DN50 flanges with 2" BSP threads that can be used for Zinc anodes or for extra connections as clean in place (CIP), cooling in dry-dock etc.

Use 120 Nm torque for the M16 nuts (Part No. 9213).

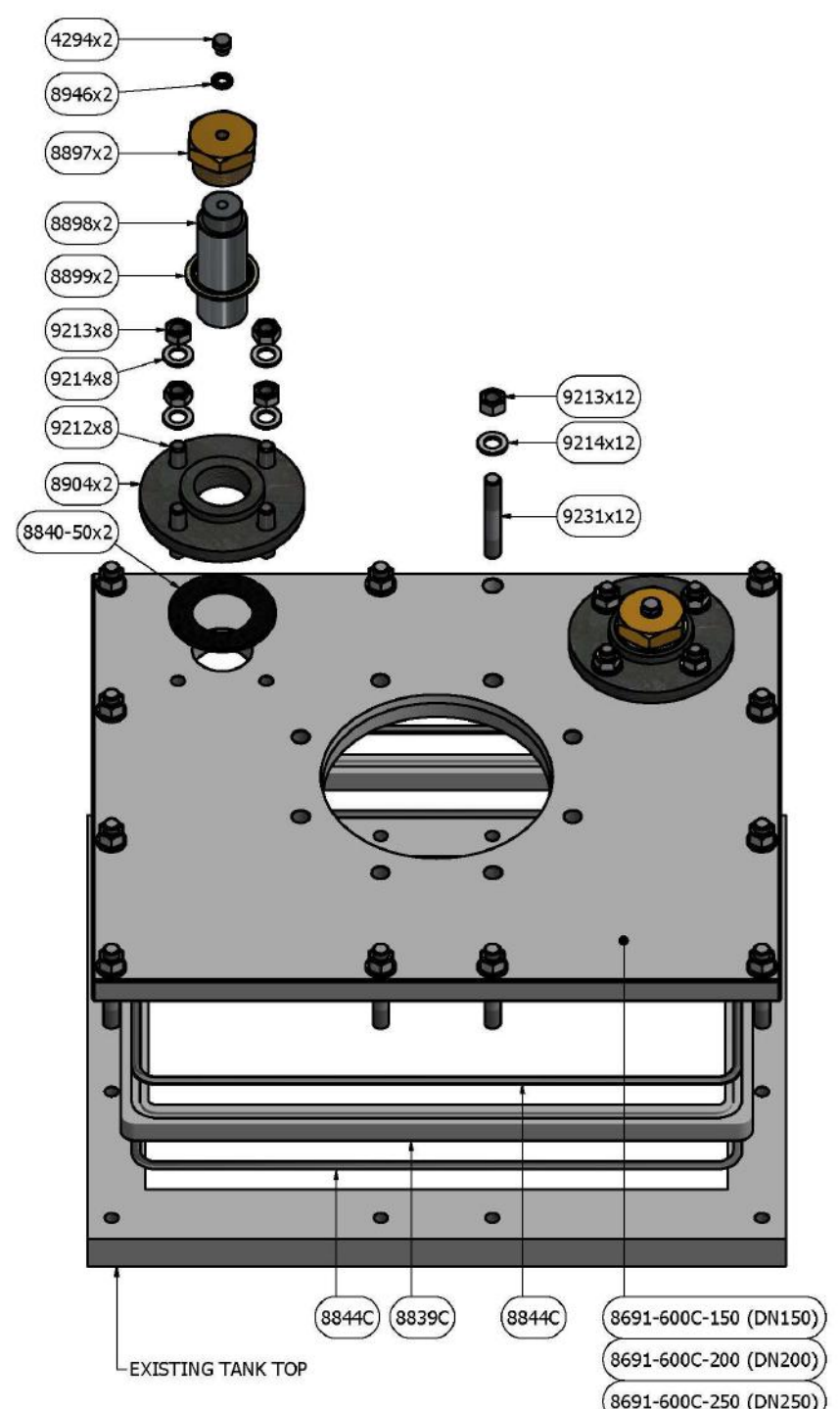

PART NAME	
4294	Plug - 1/4" BSP
8691-600C-150	SW plate
8691-600C-200	SW plate
8691-600C-250	SW plate
8839C	Gasket gland
8840-50	Gasket for flange
8844C	Gasket for gasket gland
8897	Zinc anode (complete)
8898	Zinc anode
8899	Gasket for anode
8904	Flange for anode
8946	Gasket for plug
9212	Stud bolt (M16x45)
9213	Nut (M16)
9214	Washer (Ø17)
9231	Stud bolt for SW plate (M16x80)

EXISTING TANK TOP

8844C 8839C 8844C

8691-600C-150 (DN150)
8691-600C-200 (DN200)
8691-600C-250 (DN250)

Top plate for seawater outlet

Hydroniq Rack coolers have a seawater outlet top plate that can be fitted to different sizes and standards.

A discharge pipe makes sure that all particles follow the water out.

As standard there are two DN50 flanges with 2" BSP threads that can be used for Zink anodes or for extra connections as back-flushing, etc.

Use 120 Nm torque for the M16 nuts (9213).

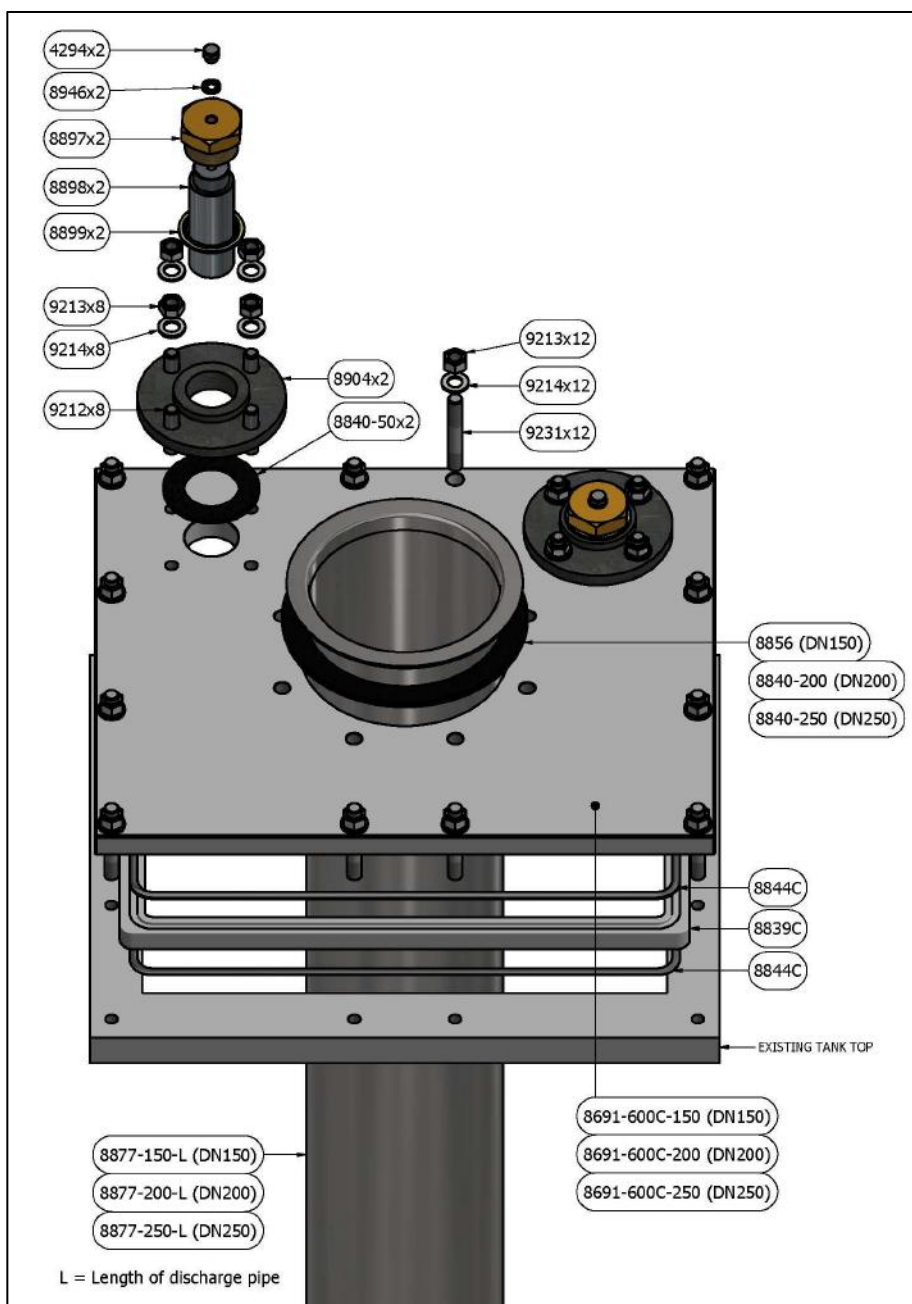

PART NAME

4294	Plug (1/4" BSP)
8691-600C-150	SW plate
8691-600C-200	SW plate
8691-600C-250	SW plate
8839C	Gasket gland
8840-50	Gasket for flange
8840-200	Gasket for discharge pipe
8840-250	Gasket for discharge pipe
8844C	Gasket for gasket gland
8856	Gasket for discharge pipe
8877-150-L	Discharge pipe
8877-200-L	Discharge pipe
8877-250-L	Discharge pipe
8897	Zinc anode (complete)
8898	Zinc anode
8899	Gasket for anode
8904	Flange for anode
8946	Gasket for plug
9212	Stud bolt (M16x45)
9213	Nut (M16)
9214	Washer (Ø17)
9231	Stud bolt for SW plate (M16x80)

Blind plate/ Top plate for Protection unit

When Hydroniq coolers are installed, it normally has one blind plate that later can be used for easy access to the system, or to have extra space to install extra elements if needed to increase capacity.

This blind plate/ protection unit top plate has one lifting lug for easy handling (delivered by Hydroniq).

The protection unit (mounted by Hydroniq before delivery) is located below this blind/ protection unit top plate.

Use 120 Nm torque for the M16 nuts (9213).

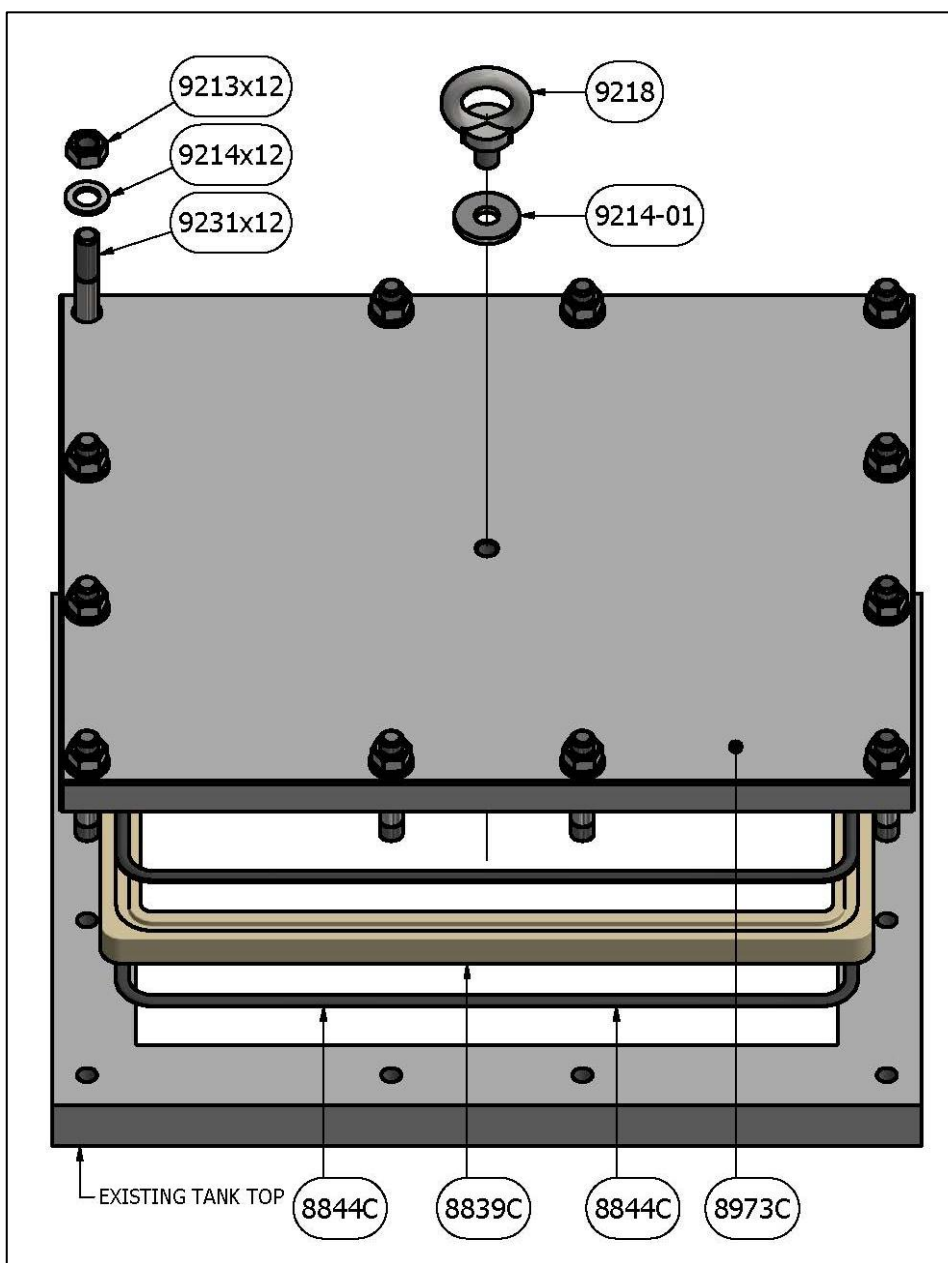

PART NAME

8839C	Gasket gland
8844C	Gasket for gasket gland
8973C	Top plate for Protection unit
9213	Nut (M16)
9214	Washer (Ø17)
9214-01	Washer for lifting eye
9218	Lifting eye
9231	Stud bolt for SW plate (M16x80)

Top plate for Rack bundle

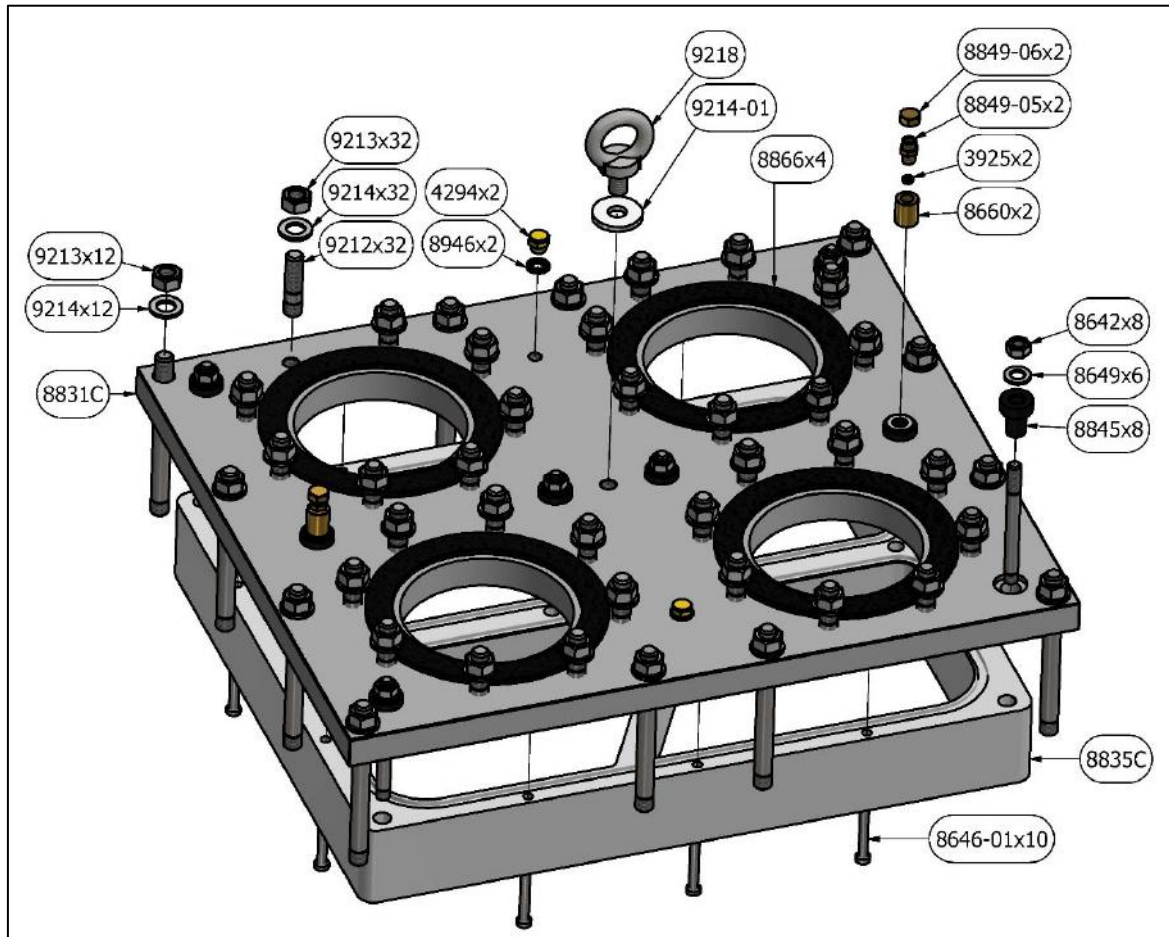

PART NAME

3925	Copper gasket for vent. bolt
4237	Nut (M12)
4294	Plug (1/4" BSP)
8644-01	Stud bolt for Rack element (M12x135)
8645	Stud bolt for Rack element (M16x200)
8646-01	Unbraco screw for distribution frame (M8x75)
8649	Washer (Ø13)
8656	Ventilation bolt (M12)
8660	Nut for ventilation bolt (M12)
8831C	Top plate – FW

PART NAME

8835C	Distribution frame
8845	Guide for M12 bolts
8849-05	Nipple (1/4" BSP)
8849-06	Nut with gasket (1/4" BSP)
8866	Gasket for FW in-/ outlet conn. (DN100)
8946	Gasket for plug
9212	Stud bolt (M16x45)
9213	Nut (M16)
9214	Washer (Ø17)
9214-01	Washer for lifting eye (Ø17)
9218	Lifting eye (M16)

Note!

When you loosen the M16 nuts around the Rack bundle (part no. 9213), you will lift up the whole Rack bundle.

When you loosen the M16 nuts around the Rack bundle (part no. 9213), the M12 nuts (part no. 8642) and the two ventilation “nuts” (part no. 8660) on the Rack bundle top plate, you will lift up only the FW top plate along with the distribution frame.

The Rack bundle will stay in place. This because the distribution frame is connected to the FW top plate with M8 unbraco screws (part no. 8646-01).

If you are going to change/ replace the gaskets (part no. 8843C) on this distribution frame, you must remove the unbraco screws.

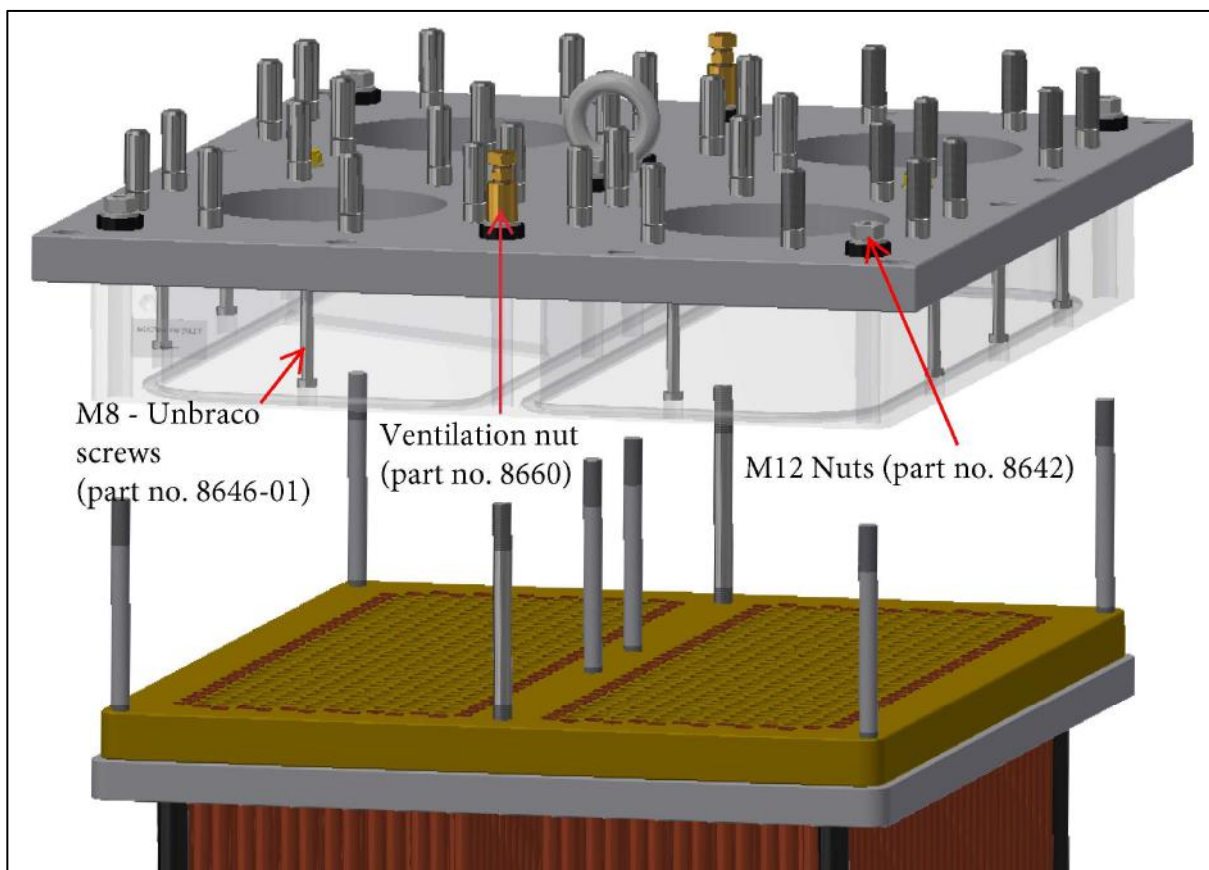

Rack bundle

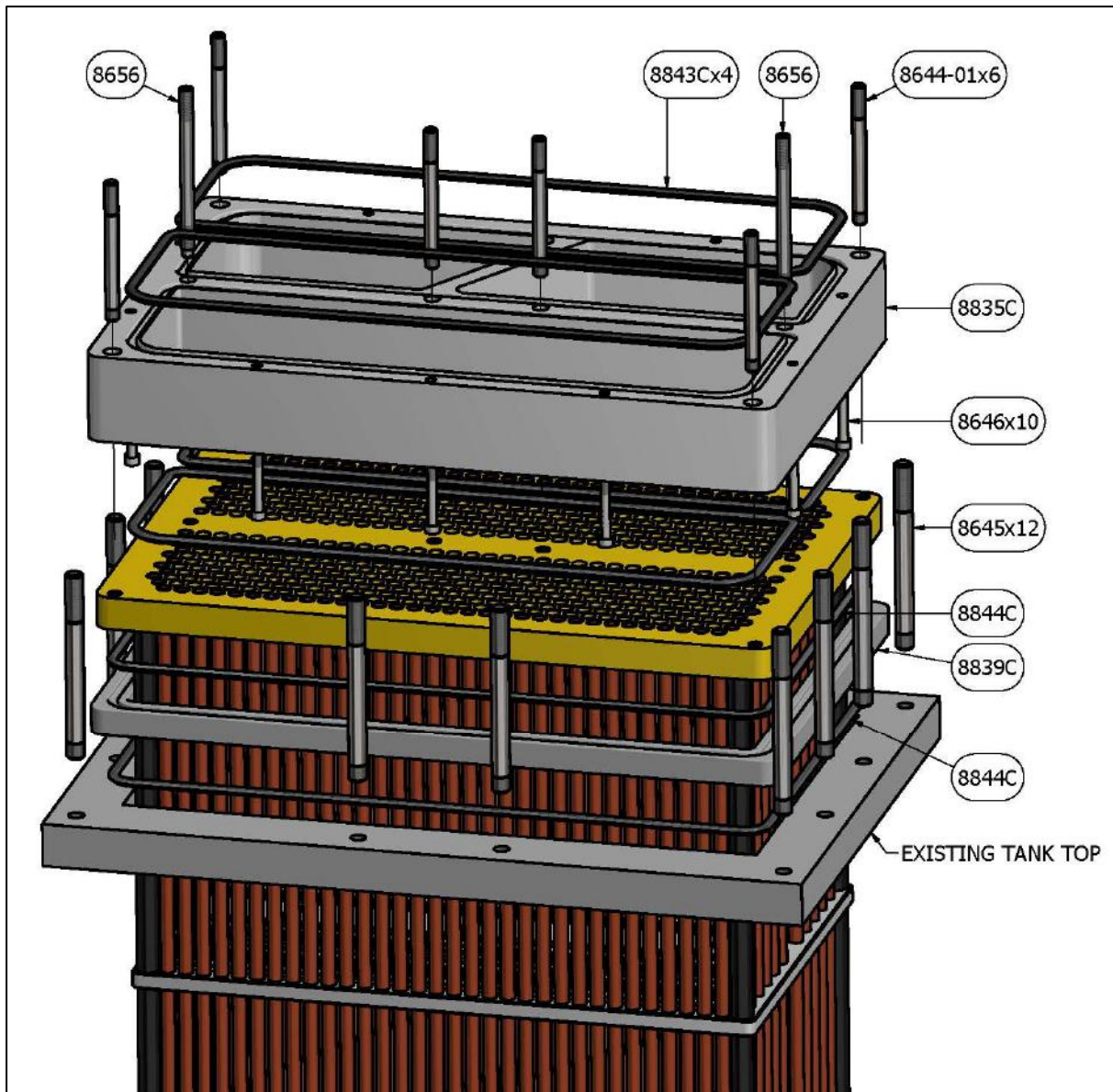

PART NAME

8644-01	Stud bolt for Rack element (M12x135)
8645	Stud bolt for Rack element (M16x200)
8646-01	Unbraco screw for distribution frame (M8x75)
8656	Ventilation bolt (M12)

PART NAME

8835C	Distribution frame
8839C	Gasket gland
8843C	Gasket for distribution frame
8844C	Gasket for gasket gland

Ventilation kit and hoses

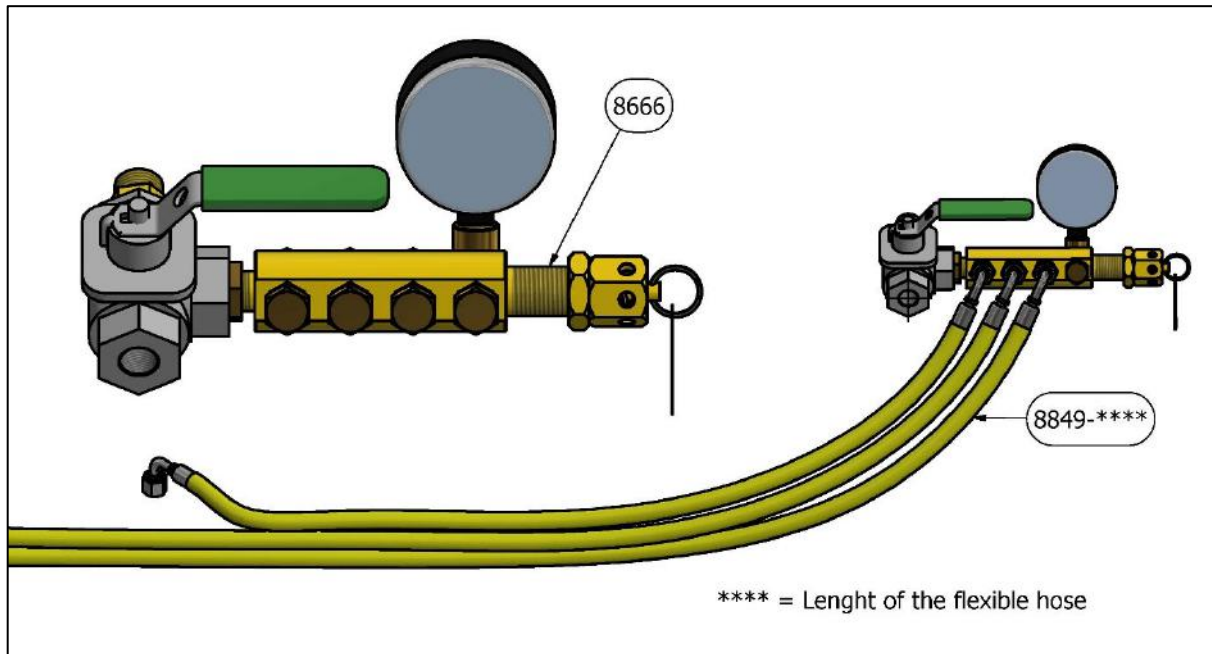

PART NAME	
8666	Ventilation kit
8849-****	Flexible hose(s)

Protection unit (Option)

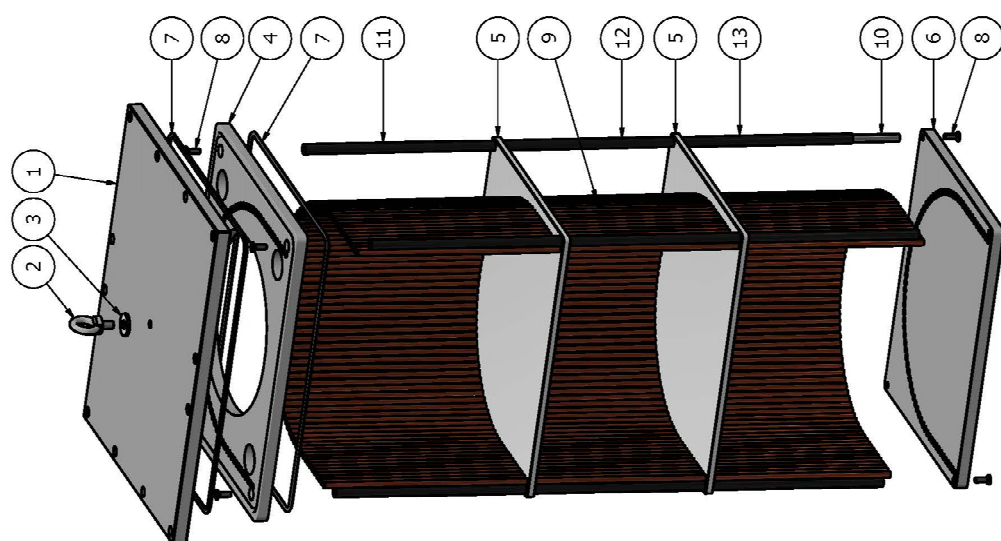

When Hydroniq Rack coolers are installed, it normally has one or more blind plates that later can be used for easy access to the system or to have extra space to install extra elements if needed to increase capacity.
The blind plate has one lifting lug for easy handling.

The protection unit (mounted by Hydroniq before delivery) is located below this blind plate.

Use 120 Nm torque for the M16 nuts (9213).

Pos. No.	PART NO. - TABLE	
	L=800 mm	L=1500 mm
10	8910-608C-750	8910-612C-1150
11	8688-240	8688-400
12	8688-240	8688-360
13	8688-240	8688-360

ITEM	QTY	DESCRIPTION	PART NUMBER	SUPPLY
13	4	Distance tube	See table	HYDRONIQ
12	4	Distance tube	See table	HYDRONIQ
11	4	Distance tube	See table	HYDRONIQ
10	4	Stiffener	See table	HYDRONIQ
9	64	Tubes - $\phi 12,7$ mm - Cu/Ni	9239	HYDRONIQ
8	2	O-ring gasket gland - 600C	8844C	HYDRONIQ
7	2	Bottom plate	8804-600C	HYDRONIQ
6	1	Baffle	8803-600C	HYDRONIQ
5	1	Gasket gland	8802-600C	HYDRONIQ
4	1	Washer for lifting eye	9214-01	HYDRONIQ
3	1	Lifting Eyebolt - M16	9218	HYDRONIQ
2	1	Blind plate - 600C	8973C	YARD
1	1	Blind plate - 600C	8973C	YARD

ITEM	QTY	DESCRIPTION	PART NUMBER	SUPPLY
<p>When drawing property of Hydroniq Coolers AS is used, it is not to be used for other purposes. Hydroniq Coolers AS is not responsible for any damage caused by the use of the drawings.</p>				
<p>Scale: 1:8</p> <p>Drawn: 16.12.2020</p> <p>Approved: RD</p> <p>Hydroniq Hydroniq Coolers AS Industrielløst, Norway</p>				
<p>Revision:</p> <p>1: Protection unit 600C</p> <p>2: 1-Pass</p>				
<p>Drawing no. 8801-600C-1-P</p>				

Filter unit (Option)

***For correct part no:
See below**

- 8950-3015* (DN150/ DN150)
- 8950-3020* (DN300/ DN200)
- 8950-3025* (DN300/ DN250)

REV	DESCRIPTION	REVISION HISTORY	DATE
A	Change floater (pos. 4)		01.06.2017
B	Added a o-ring on top of manual handle		27.07.2018
C	Change material from Brass to AISI 316 L		21.09.2018

Note!
 3* Std. length is 1000 mm
 Part no. for 800 mm length is 8741-800
 7* Part no. for 800 mm length filter is 8731-800-ny
 10* Part no. for 800 mm length filter is 8732-800
 11* Part no. for 800 mm length filter is 8735-800

ITEM	QTY	DESCRIPTION	PART NUMBER	MATERIAL
25	1	Silicone gasket for filter	8737-01	Silicone
24	1	O-ring inside manual handle - Ø8x2	8749	NBR70
23	1	Washer for lifting eye	9214-01	AISI 316 L
22	1	Locking nut - M16	9240	A4
21	3	Hex Nut - M16	4261	A4
20	1	Washer, big - M16	9214-03	A4
19	8	Stud bolt - M16 x 100	9221	A4
18	9	Washer - M16	4266	A4
17	8	Hex Nut - M16	4260	A4
16	1	Sealing ring - 30 x 7,5 mm	8717	Rubber
15	1	Unbraco screw - M8 x 40	9220	A4
14	2	O-ring for manual handle	8736	NBR70
13	1	O-ring for stiffener	8744	NBR70
12	1	Lifting eye - M16	8958	EZ
11	1	Stiffener for manual handle - Ø20	8735-02*	AISI 316 L
10	1	Stiffener for filter unit - Ø16	8732-08*	AISI 316 L
9	1	Locking flange - M16	8719	A4/AISI 316 L
8	1	Manual handle	8734	PPH
7	1	Pipe for filter unit	8731-02*	Polyuretan
6	1	Bottom plate 2 - Filter unit	8733-02	AISI 316 L
5	1	Bottom plate 1 - Filter unit	8733-01	Polyuretan
4	1	Floater for SW filter	8738-08	Polyuretan
3	1	Filter	8741-1000*	AISI 316 L
2	1	Amplifier for filter unit	8730	PPH
1	2	Gasket for amplifier	8740	Neoprene

Scale	1:12
Drawn	20.12.2016
Approved	
Hydroniq Coolers AS Aker 22, Birkedal, Norway	
Rep: A3 No. A Date B Register C D E	Rack Working drawing SW filter unit Version 2
Drawing no. 8950-3025-P	6

HOW TO ORDER SPARE PARTS

When ordering please inform:

1. Rack Cooler type.
2. Order no.
3. Part no.
4. Quantity.

1. The Rack cooler type and order no. can be found on the frontpage of the Installation manual
2. Part no. you will find in the section “Part list and Illustrations” of this User manual.

Note!

HYDRONIQ disclaims all liability for damage due to the use of non-genuine replacement parts.

Orders for replacement parts should be sent to:

Hydroniq Coolers AS
Ellingsøyvegen 740
N-6057 Ellingsøy
Norway

Tel: + 47 70 10 42 00

E-mail: info@hydroniq.no

ADDITIONAL INFORMATION

Please refer to the Hydroniq Installation manual for additional information of the design and installation of the Rack cooler.

