



Smappee (Solar) Energy Monitor Installation Manual

English

Version: 2.2, as of 20/2/2017

© 2013-2017 Smappee NV. All rights reserved.

Specifications are subject to change without notice.

All product names are trademarks of their respective companies.

Table of contents

A word from our CEO.....	3
Before you Start.....	4
Safety instructions.....	5
Connect Smappee to your Wi-Fi.....	6
Understand the Electrical Network of your Home.....	7
Connect Smappee to your Fuse Box	9
Single Phase Installation Without Solar.....	11
Single Phase Installation With Solar	14
Three Phase Installation Without Solar	18
Three Phase Installation With Solar.....	21
Special Instructions: Three Phase Delta Installation	27
US Split Phase Installation Without Solar	29
US Split Phase Installation With Solar	32
Declaration of Conformity	36

A word from our CEO



Welcome to the world of Smappee

You will soon notice that Smappee offers nothing but benefits. Immediately after its installation, Smappee will give you clear insight into your energy consumption. This will allow you to achieve savings straight away, without any concessions to comfort. And that's not all: you can now leave the house without any worries. After all, you can simply use the app to check whether or not you have turned off all your appliances.

Smappee will soon become part of your life. You will automatically become more conscious of how you use energy, which will contribute to a better environment for us all. Not only for us, but also for the following generations! And that might just be the biggest benefit of all.

Stefan Grosjean

Stefan Grosjean,
Founder and C.E.O. of Smappee

Before you Start

Overview

The Smappee monitor measures the energy consumption of your electrical appliances in your home and the production of your solar panels.

You can view the energy consumption and production of your home real-time on your smartphone or tablet. The Smappee app gives you direct insight into your energy consumption and costs.

How it all works

The Smappee monitor is connected to your home **Wi-Fi** router, to communicate with the Smappee cloud and the App.

Then, the Smappee monitor is installed near to the **fuse box**. The sensors (**current clamps**) are connected to particular wires in or near the fuse box, so that Smappee can measure the energy consumption of your home.

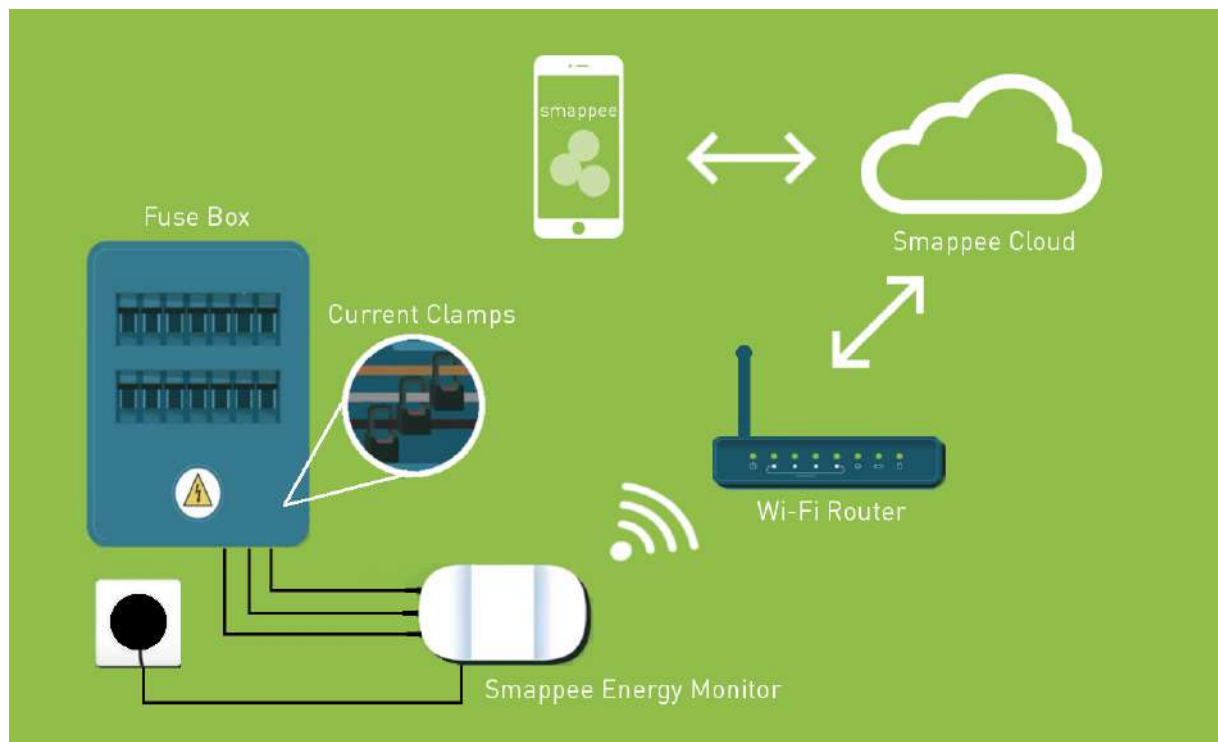

This manual helps you with all the steps needed for this installation.

Where to Start

Step	Description	Page
1	Read the Safety Instructions	5
2	Connect Smappee to your Wi-Fi network	6
3	Understand your Home Electricity Network	7
4	Connect Smappee to your Fuse Box	9

Safety instructions

Warnings

Please observe the following safety precautions to avoid possible electric shocks, fire, or personal injury:

- Use the product only as specified as otherwise the safety of the product is not sufficient.
- Do not use the product in environments with explosive gas or vapours, nor in damp or wet environments.
- Do not use damaged power cords and cables. Check the power cords and cables for damaged insulation and exposed metal. Check the connection of the power cords.
- Use only the power cord and cables that are supplied with the product.
- Do not use the product if it is damaged.
- Reparations should only be done by authorized technicians.
- Do not open the product. There is a potential for exposure to hazardous voltage.
- Use only specified replacement parts.
- Do not connect the product to a voltage higher than 240 V.
- Turn off the main power switch before you start the installation of the product.
- Follow local and national safety regulations for installation and use of electrical equipment.

Maintenance

- Clean only the outside with a dry, clean cloth.
- Do not use abrasive agents or solvents.

Technical specifications

- Dimensions: 16 cm (L) x 10 cm (W) x 3,5 cm (H)
- Weight: 300 grams
- Wi-Fi 802.11 b/g/n 2.4 GHz
- Work temperature: 5°C to 40°C
- Storage temperature: -10°C to 60°C
- Relative humidity: 0-80% 5°C to 40°C
- Sealing IP 20.
- Work altitude: 0 to 2.000 meters
- EMC: EN 55022 (Class B)
- Overvoltage category: 300 V/CAT II
- ~110-240V 50/60Hz Max 5W

Connect Smappee to your Wi-Fi

Overview

This section shows how to connect the Smappee to your Wi-Fi network.

Keep your Wi-Fi password secure

Security is important for Smappee. Therefore, the Smappee app securely transfers the password of your Wi-Fi network to the Smappee Energy monitor, so that it can connect to your Wi-Fi network

How it works

A new Smappee Energy monitor opens a temporary ad-hoc Wi-Fi network. When you perform the installation steps in the Smappee App, you connect your smartphone to that ad-hoc Wi-Fi network.

Then, the Smappee app asks you for the password of your home Wi-Fi network, and sends it directly to the Smappee Energy monitor.

As soon as the Smappee is connected to your home Wi-Fi network, it connects to the Smappee Cloud and is there linked to your App account.

Step by Step

Here are the steps you should perform for connecting your Smappee Energy monitor to your Wi-Fi network:

1. Download the app from the Apple App Store or Google Play.
2. Open the app and create your personal user account.
3. When using the App for the first time, you'll see three bubbles: Install, Buy, Logout. To proceed, press 'Install'.
4. Follow the instructions in the app.
5. Then, continue with section "Understand the Electrical Network of your Home", on page 7.



Understand the Electrical Network of your Home

Overview

For a correct installation of the sensors (current clamps), it is important that you understand the type of the electrical installation of your home.

Please find below some tips to identify which installation you have in your home.

Types









There are four major types of networks.

Type of installation	In what countries
1 phase	Most common type in homes and apartments in Europe, Asia and many other parts of the world.
3 phase ("Star")	Common type in modern and large homes in Europe, Asia and many other parts of the world.
3 phase "Delta"	Occasionally found in Denmark and Belgium only
Split phase US	Most common type in the US and Canada.

If you are still unsure, please see the additional information on the next page.

What type of electricity network do I have?

This table helps you to identify the type of network of your home.

Type of Installation	Symbol on your electricity meter	Number of main cables in your fuse box	Example
1 phase		2 cables (1 phase + 1 neutral)	
3 phase ("STAR")		4 cables (3 phase cables + 1 neutral)	
3 phase delta		3 cables (3 phase cables, NO neutral)	
Split Phase US		2 cables (2 phase cables)	

Connect Smappee to your Fuse Box

Introduction

This chapter describes how to connect the Smappee monitor to your fuse box.

Remember! Before you can connect the Smappee monitor to the fuse box you must first connect it to your Wi-Fi network as described in the previous chapters.

Consult a certified electrician

If you do not have knowledge about electrical installations, we strongly recommend to consult a certified electrician for the installation.

Installation Videos

Installation videos are available on our support website or on YouTube:

<http://www.smappee.com/support/>

<https://www.youtube.com/channel/UCFBFXohTW60YDA-TKjCh7sg>

Content of the Box

Depending on your region, you find the following items in the Smappee box.

- 1 Smappee Energy monitor or 1 Smappee Solar Energy monitor
- 1 power cord (type depending on your region)
- 3 or 6 current clamps (2 or 4 in the US)
- 1 Comfort Plug (which is not needed during the installation)

Tools

For an easy and fast installation, we recommend to have a few tools ready:

- Screwdriver
- Flashlight

Choose the Type of Installation

This section explains the installation steps for various types of electrical installations. Please select the type on the list and continue at the page indicated.

Installation type	Solar Panels	Continue on Page
1 phase	No Solar	11
1 phase	With Solar	14
3 phase star	No Solar	18
3 phase star	With Solar	21
3 phase delta	With or without Solar	27
Split phase (US, Canada)	No Solar	29
Split phase (US, Canada)	With Solar	32

If you are not sure of the installation type of your home, please refer to page 7.

Single Phase Installation Without Solar

Introduction

The following steps describe **the single-phase connection without solar panels**.

Instructions

Step 1: First please locate your fuse box and utility meter.

Step 2: Turn of the power and open up the fuse box. (you might need a screwdriver for this).



Step 3: You'll see 2 coloured wires coming from the utility meter. Ignore the blue wire (neutral wire) and any green/yellow wires (ground).

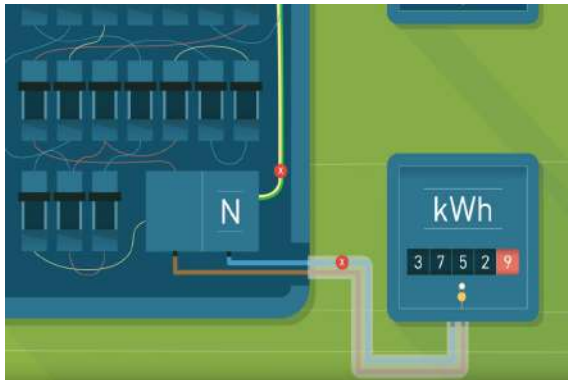

Step 4: The remaining wire is called the phase wire. It's usually grey, brown or black. In some installations other colours can be used for the phase wire.

Step 5: Take a current clamp and find the little arrow on the clamp. Check for the symbol **L ← K** in the clamp. The arrow shows the direction of the energy flow. Make sure that **L** points in the direction of the appliances (energy users) and **K** in the direction of the electricity meter.



Place the current clamp over the brown (or phase) cable. Make sure that you properly close the clamp by pressing your thumb on the side until you hear a click. Please pay close attention to the direction of the arrow!

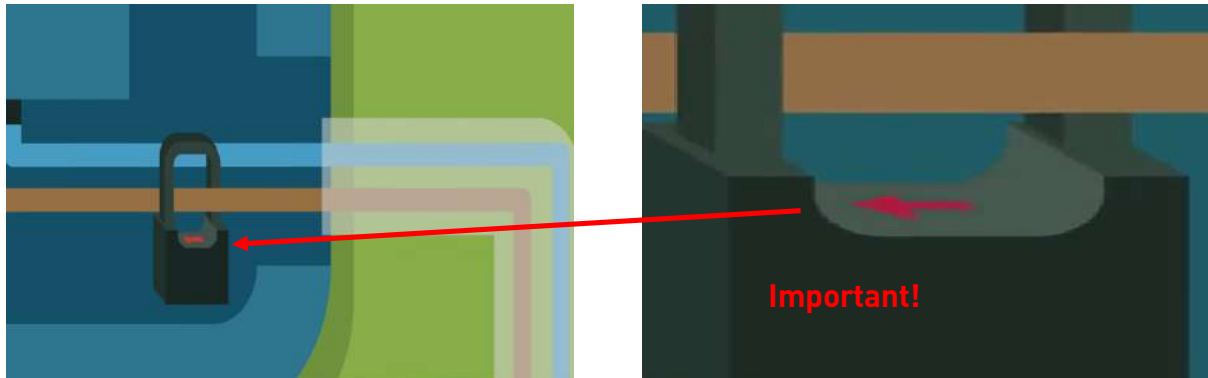

Step 6: Plug the ends of the current clamp cable into input 1 of the Smappee monitor

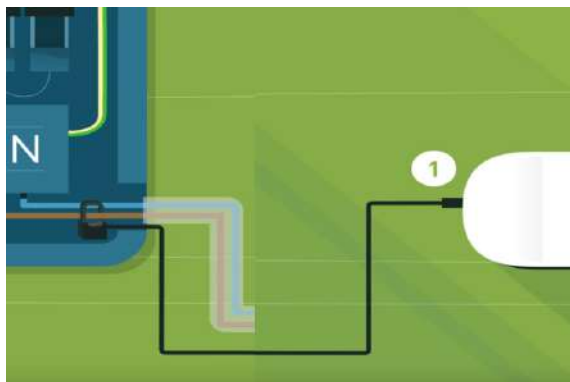

Step 7: Now close the fusebox (be carefull not to jam the cable) and turn the power back on.

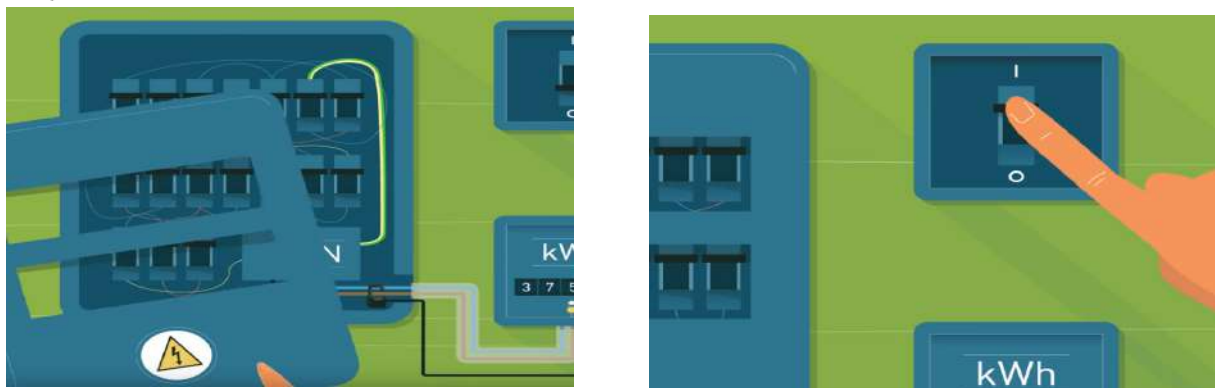

Step 8: Plug the power cord for the monitor into the wall socket and wait until the monitor shows a green heartbeat.

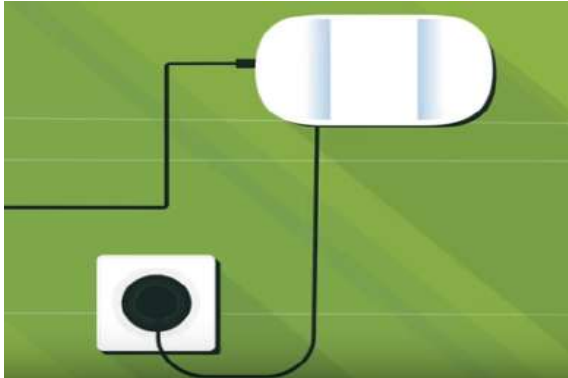

Step 9: You can now get started with the Smappee app.

Single Phase Installation With Solar

Introduction

The following steps describe **the single-phase connection with solar panels.**

Instructions

Step 1: First please locate your fuse box, utility meter and solar inverter.

Step 2: Turn of the power and the solar inverter, then open up the fuse box. (you might need a screwdriver for this)



Step 3: You'll see 2 coloured wires coming from the utility meter. Ignore the blue wire (neutral wire) and any green/yellow wires (Grounding).

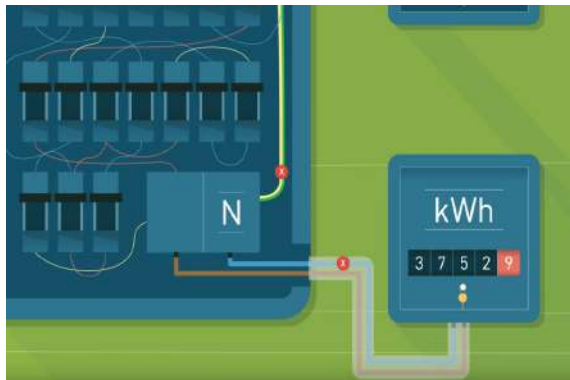

Step 4: The remaining wire is called the phase wire. It's usually grey, brown or black. In some installations other colours can be used for the phase wire.

Step 5: Take a current clamp and find the little arrow on the clamp. Check for the symbol

L ← K in the clamp. The arrow shows the direction of the energy flow. Make sure that **L** points in the direction of the appliances (energy users) and **K** in the direction of the electricity meter.



Place the current clamp over the brown (or phase) cable. Make sure that you properly close the clamp by pressing your thumb on the side until you hear a click. Please pay close attention to the direction of the arrow!

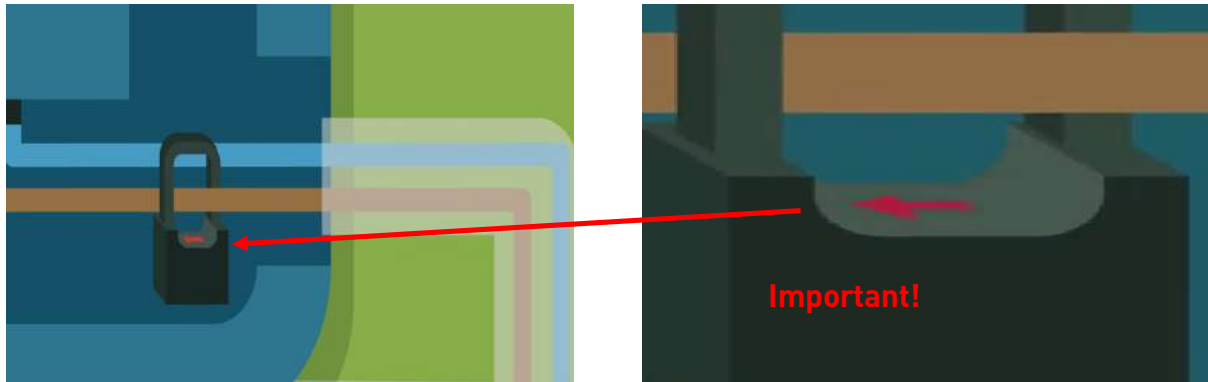

Step 6: Take a V-cable with an unmarked leg and a leg marked solar. Plug the cable of the current clamp in the unmarked leg of the V-cable and plug the other end of the V-cable in input 1 of the Smappee. Please respect the polarity of the plug!

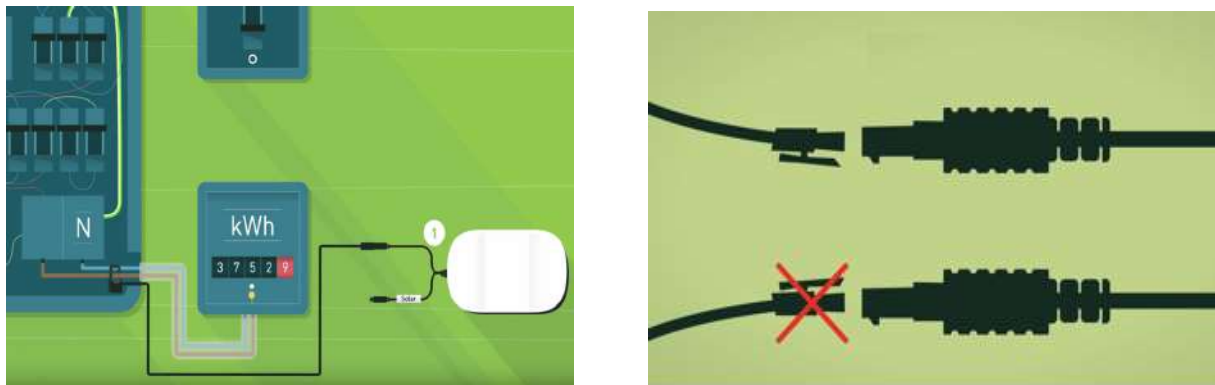

Step 7: Now locate the solar inverter and check the wires running to your fuse box. You'll see 1 phase wire which is usually black, brown or grey.

Step 8: Take a current clamp (CT) and clamp it around the phase wire with the little arrow on the clamps pointing away from the utility meter. Make sure that you properly close the clamp by pressing your thumb on the side until you hear a click.

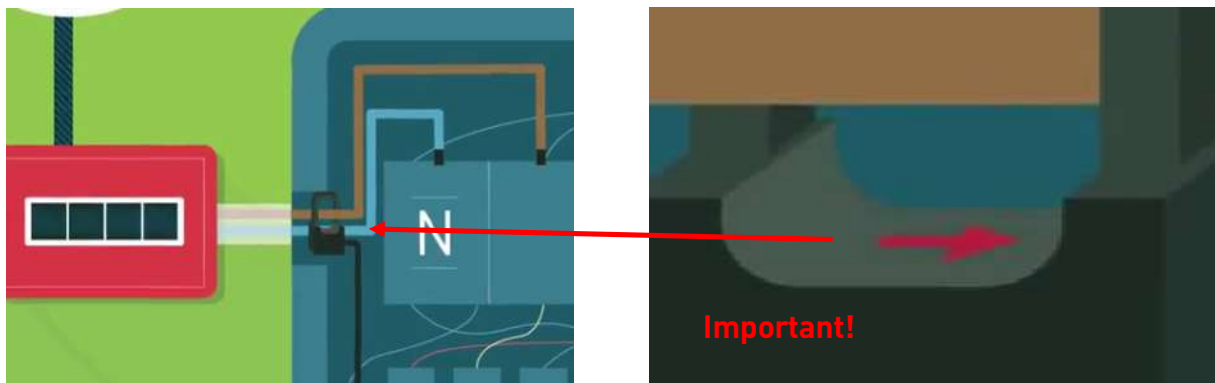

Step 9: Please make sure there are no other cables branching off between the current clamp and the solar inverter. If there are make sure you put the clamp closer to the solar inverter, before these other cables branch off.

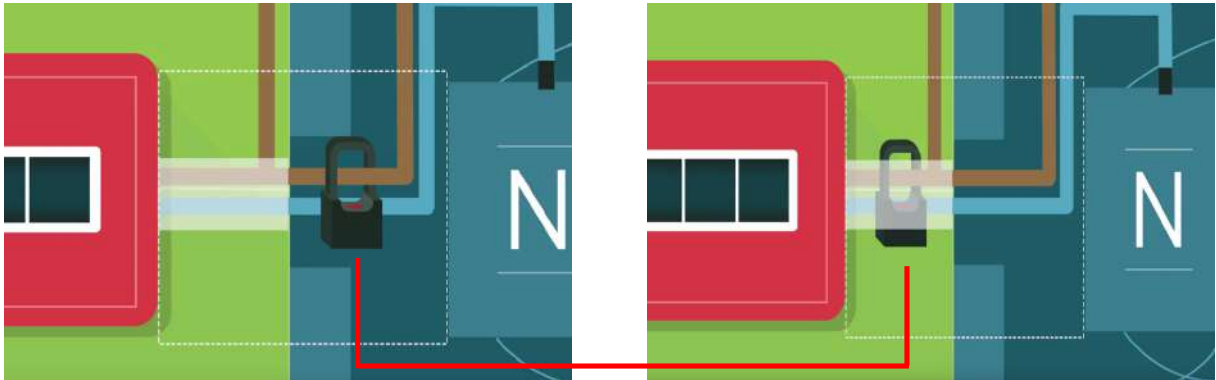

Step 10: Now, plug the cable of the current clamp in to the leg marked “solar” of the V-cable already connected to input 1 of the Smappee. Again, please respect the polarity of the plug!

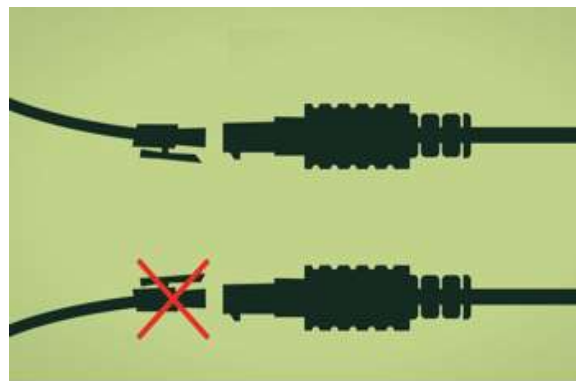
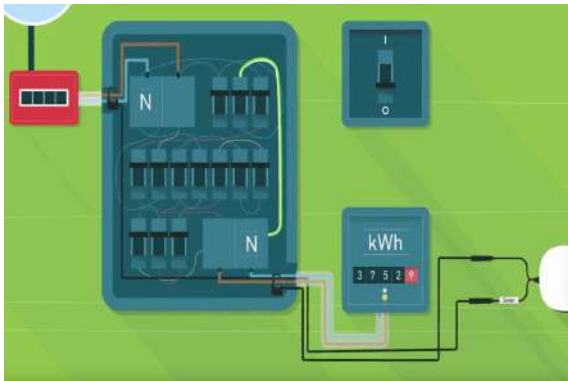

Step 11: Now close the fusebox (be carefull not to jam the cable) and turn the power back on.



Step 12: Plug the power cord for the monitor into the wall socket and wait until the monitor shows a green heartbeat.

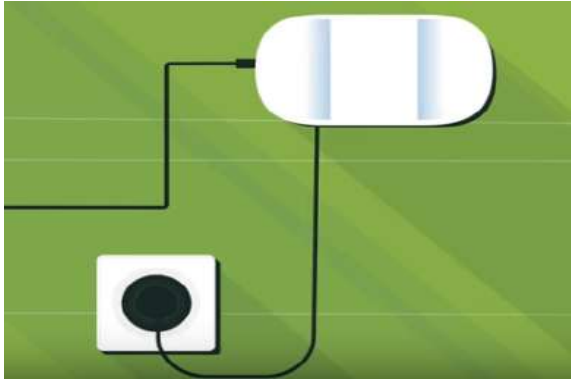

Step 13: You can now get started with the Smappee app.

Three Phase Installation Without Solar

Introduction

The following steps describe **the three-phase connection without solar panels.**

Note: Please refer to page 27 for special instructions if you have a Three phase Delta installation!

Instructions

Step 1: First please locate your fuse box and utility meter.

Step 2: Turn of the power and open up the fuse box. (you might need a screwdriver for this)



Step 3: You'll see 4 coloured wires coming from the utility meter. Ignore the blue wire (neutral wire) and any green/yellow wires (Grounding).

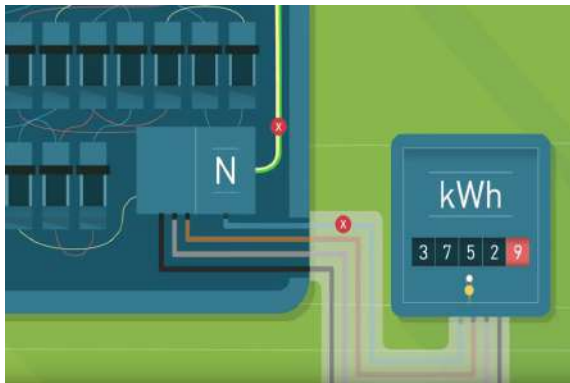

Step 4: The remaining wires are called the phase wires. They're usually grey, brown or black. In some installations other colours can be used for the phase wire.

Step 5: Take a current clamp and find the little arrow on the clamp. Check for the symbol **L ← K** in the clamp. The arrow shows the direction of the energy flow. Make sure that **L** points in the direction of the appliances (energy users) and **K** in the direction of the electricity meter.



Place the current clamp over the brown (or phase) cable. Make sure that you properly close the clamp by pressing your thumb on the side until you hear a click. Please pay close attention to the direction of the arrow!

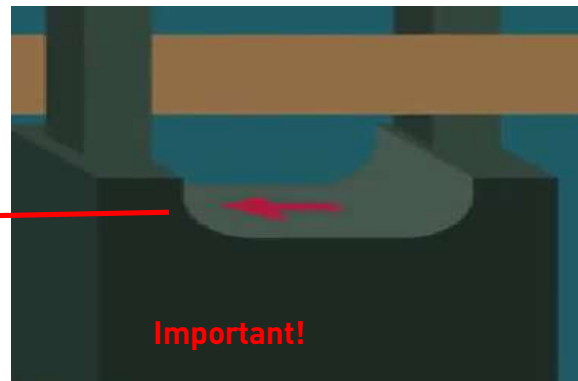
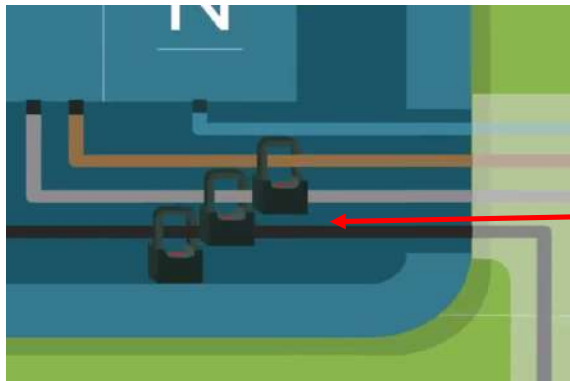

Step 6: Plug the ends of the current clamp cables into input 1, 2 and 3 of the Smappee monitor.



Step 7: Now close the fusebox (be carefull not to jam the cable) and turn the power back on.



Step 8: Plug the power cord for the monitor into the wall socket and wait until the monitor shows a green heartbeat.

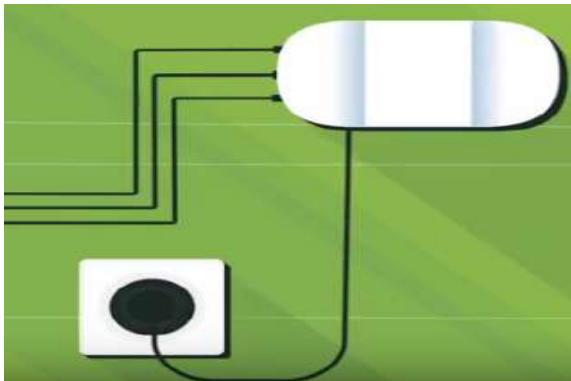

Step 9: You can now get started with the Smappee app.

Three Phase Installation With Solar

Introduction

The following steps describe **the three-phase connection with solar panels.**

CAUTION! This installation should be done with the help of a certified electrician.

Instructions

Step 1: First please locate your fuse box, utility meter and solar inverter.

Step 2: Turn of the power and the solar inverter, then open up the fuse box. (you might need a screwdriver for this)

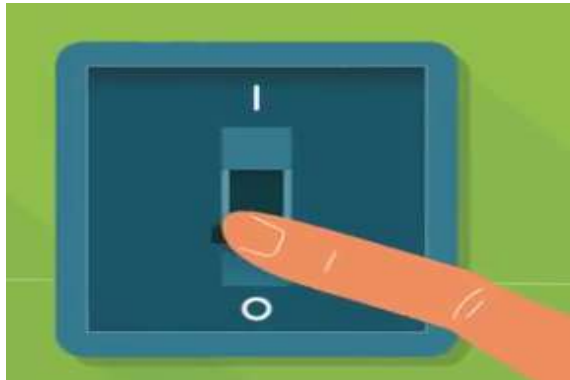

Step 3: You'll see 4 coloured wires coming from the utility meter. Ignore the blue wire (neutral wire) and any green/yellow wires (Grounding).

Step 4: The 3 wires are called phase wires. They're usually grey, brown or black. In some installations other colours can be used for the phase wire.

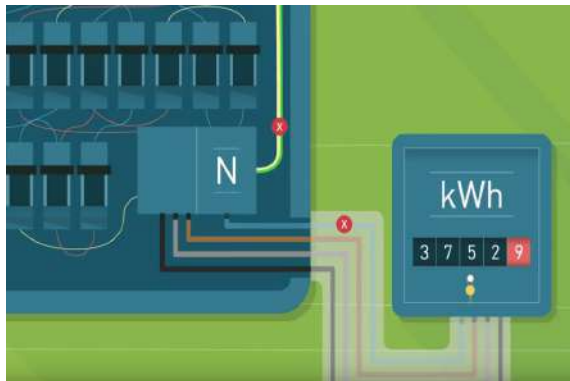

Step 5: Take a current clamp and attach the green label marked C1 on the cable close to the clamp. Attach the other green label marked C1 to the other end of the cable.

Step 6: Repeat these steps for the other two phase wires with the current clamps marked C2 and C3.

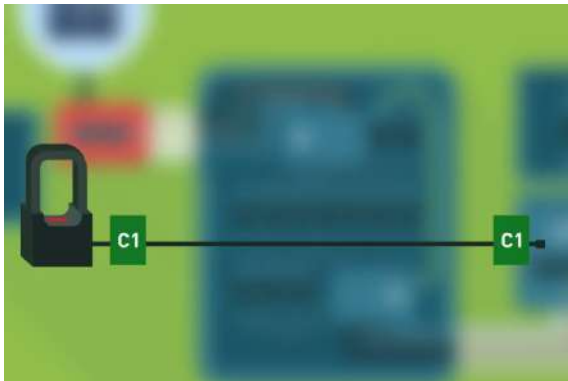

Step 7: Clip the current clamps over the three phase wires with the little arrow on the clamp pointing away from the utility meter. Make sure that you properly close the clamp by pressing your thumb on the side until you hear a click.

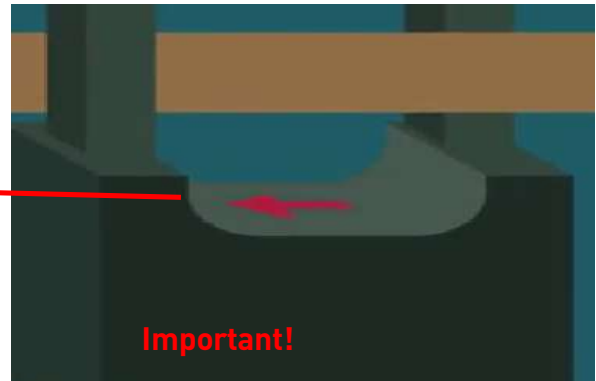
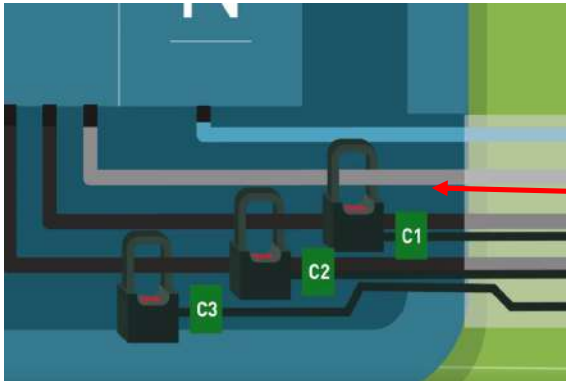

Step 8: Now locate the solar inverter and check the wires running to your fuse box. In most cases you'll see 3 phase wire which are usually black, brown or grey.



Step 9: Take a current clamp and attach the yellow label marked S1 on each end of the clamp cable.

Step 10: Repeat these steps for the other two phase wires with the current clamps marked S2 and S3.

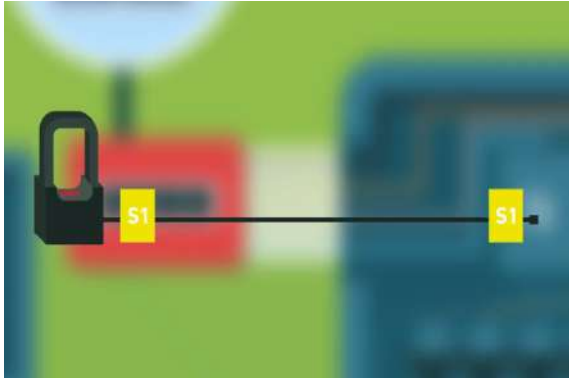

Step 11: Determine which of the three phase wires has the same phase as the wire with the marked C1. You can do this by following each of the three phase wires to find the one connected to the wire marked C1.

Step 12: Your electrician can measure the voltage between each of the 3 wires and the wire with the clamp marked C1. The phase wire with 0 volt difference is the one with the same phase.

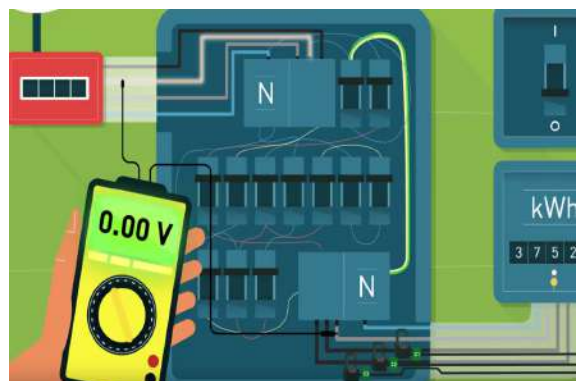
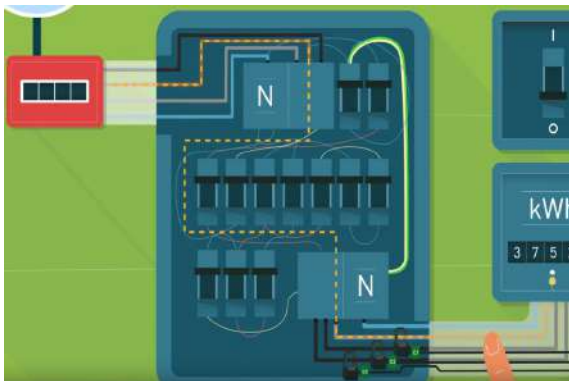

Step 13: Clip the current clamp marked S1 on the wire with the same phase with the little arrow on the clamp pointing away from the solar inverter. Make sure that you properly close the clamp by pressing your thumb on the side until you hear a click.

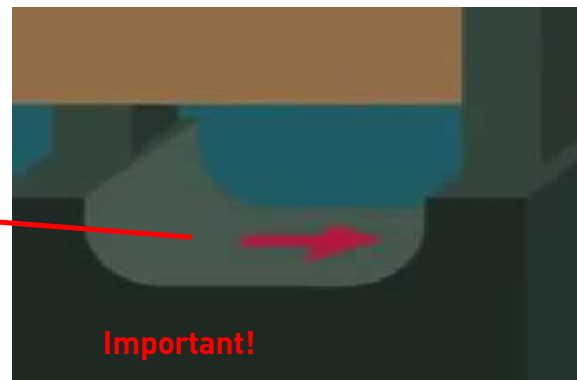
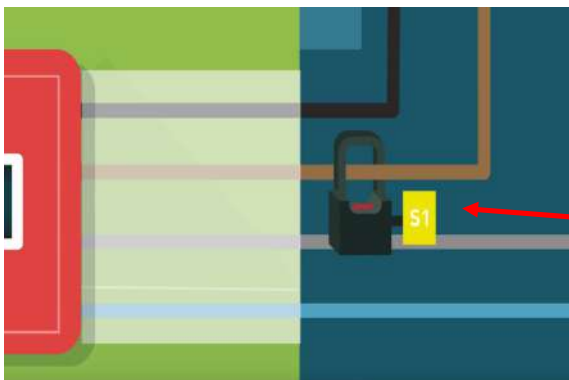

Step 14: Please make sure there are no other cables branching off between the current clamp and the solar inverter. If there are make sure you put the clamp closer to the solar inverter, before these other cables branch off.

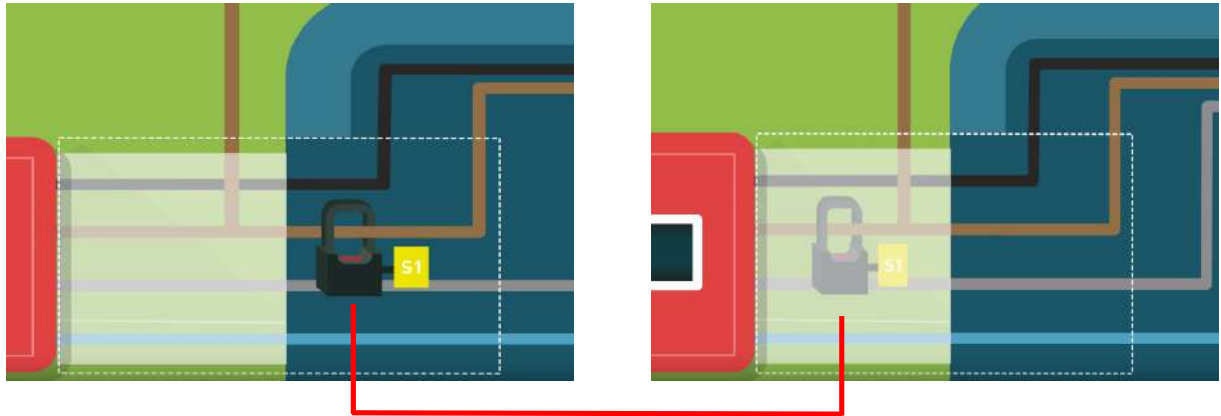

Step 15: Repeat these steps for the other two phase wires with the current clamps marked S2 and S3. Make sure you clip each of them over the correct wire that has the same phase as the wires with the clamps marked C2 or C3.

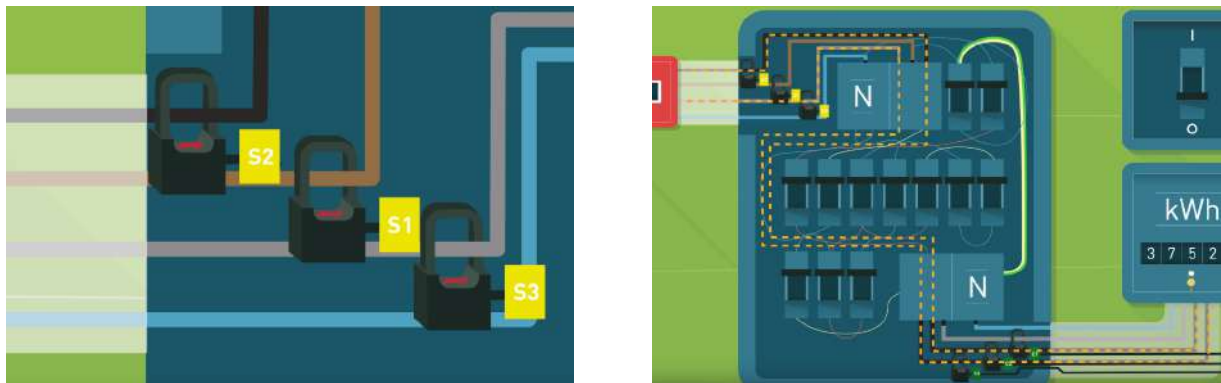

Step 16: If there are only 1 or 2 phase wires running from your solar inverter to your fuse box then you only need to install 1 or 2 current clamps. In that case you will have some CT clamps left over.



Step 17: Now take 3 V-cables each with 1 unmarked leg and 1 leg marked solar.

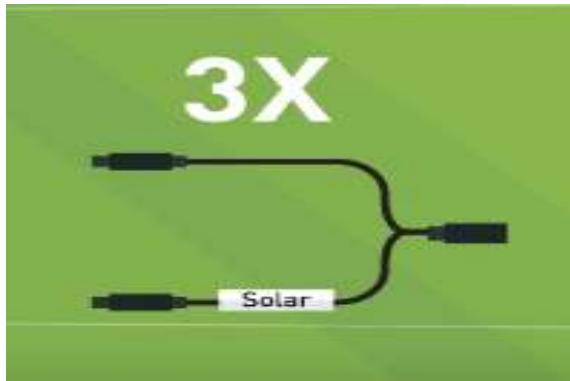

Step 18: Plug the cable marked C1 into the unmarked leg of a V-cable and the cable marked S1 into the leg marked solar. Please respect the polarity of the plugs!

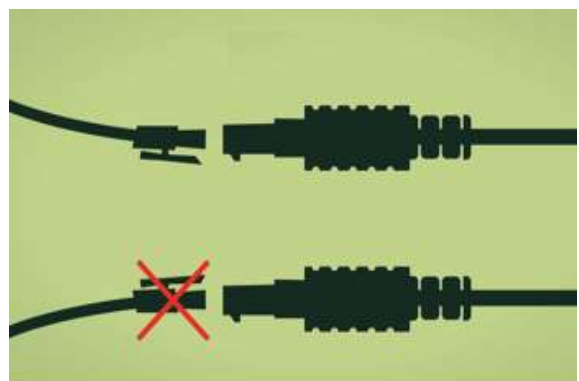

Step 19: Plug the other end of the V-cable into input 1 of the Smappee.

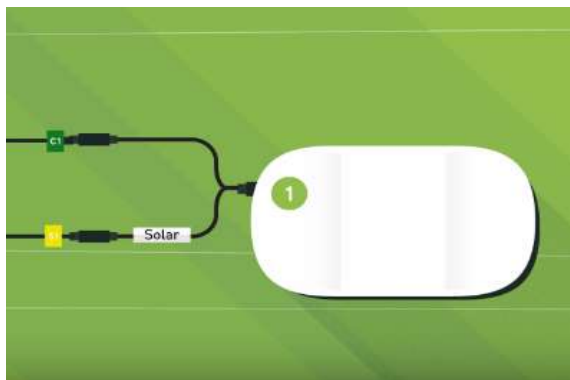

Step 20: Now repeat these steps for the clamp marked C2 and S2 and the clamps marked C3 and S3. Remember to make sure that the cables on 1 V-cable belong to the same phase.

Step 21: Now plug the V-cables into input 2 and 3 of the Smappee.

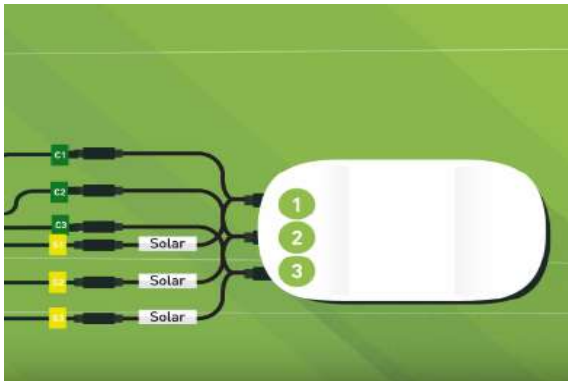

Step 22: Now close the fusebox (be carefull not to jam the cable) and turn the power back on.



Step 23: Plug the power cord for the monitor into the wall socket and wait until the monitor shows a green heartbeat.

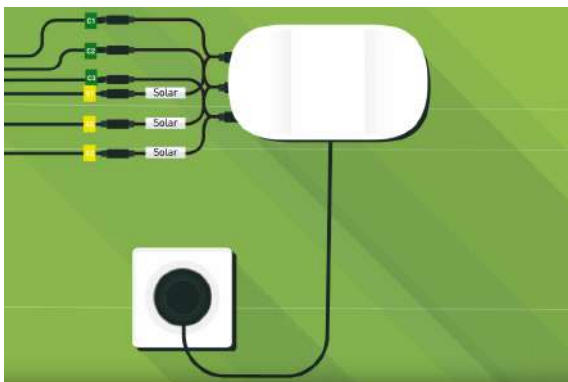

Step 24: You can now get started with the Smappee app.

Special Instructions: Three Phase Delta Installation

Introduction

Please find below the special instructions for a three phase delta installation.

A three phase delta installation is slightly different from the normal three phase installation.

A three phase delta installation does not have a neutral wire, therefore you will only see 3 phase cables and no neutral wire.

Special instructions: Installation without solar

The installation instructions for a 3 phase delta installation are identical to the steps described in the chapter “Three Phase Installation Without Solar” on page 18.

There is only 1 exception:

Step 3: You'll see 4 colored wires coming from the utility meter. Ignore the blue wire (neutral wire) and any green/yellow wires (Grounding).

In step 3, the instructions tell you to ignore the blue wire and any green/yellow wires.

A delta network does not have a neutral wire, therefore you will not see a blue wire.

Special instructions: Installation with solar

You can follow the installation instructions in the manual on page 21 up to step 10. Then, please follow the installation instructions below for the solar panels:

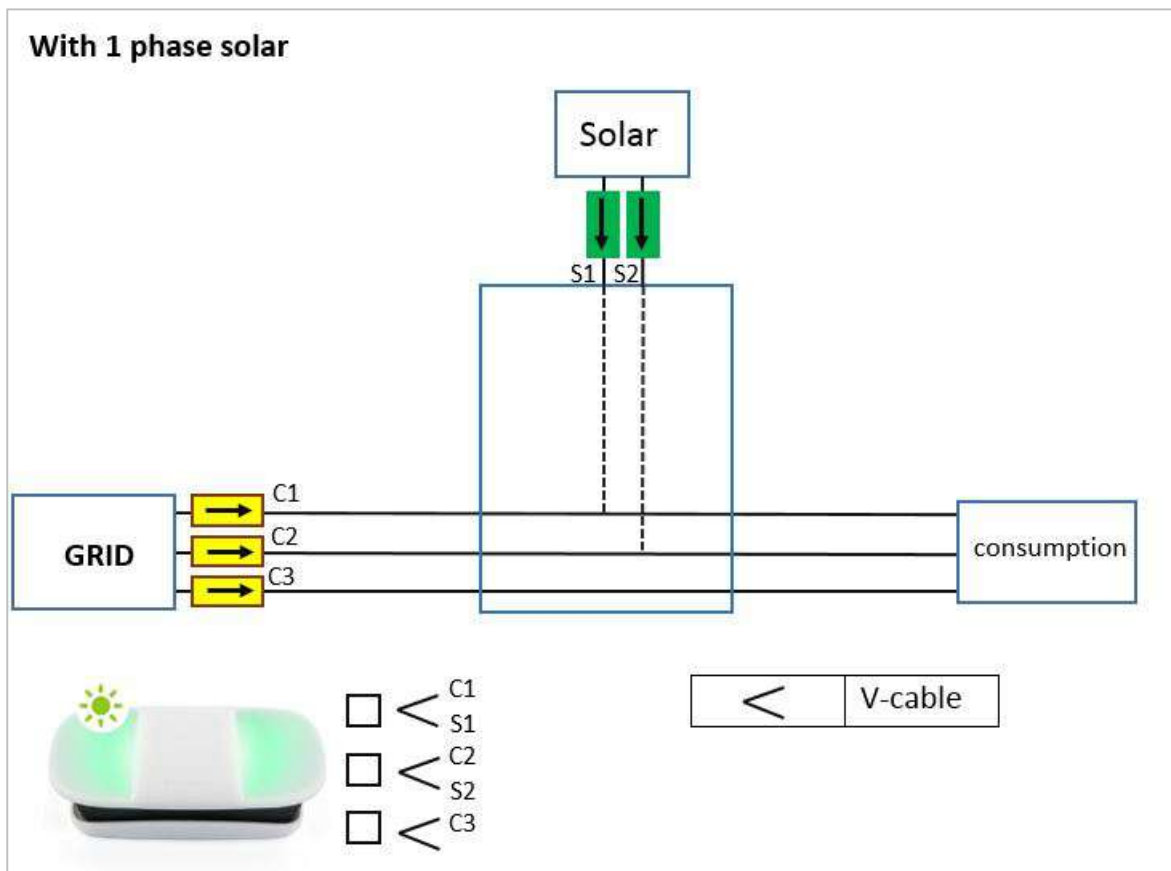

With 2 phase solar

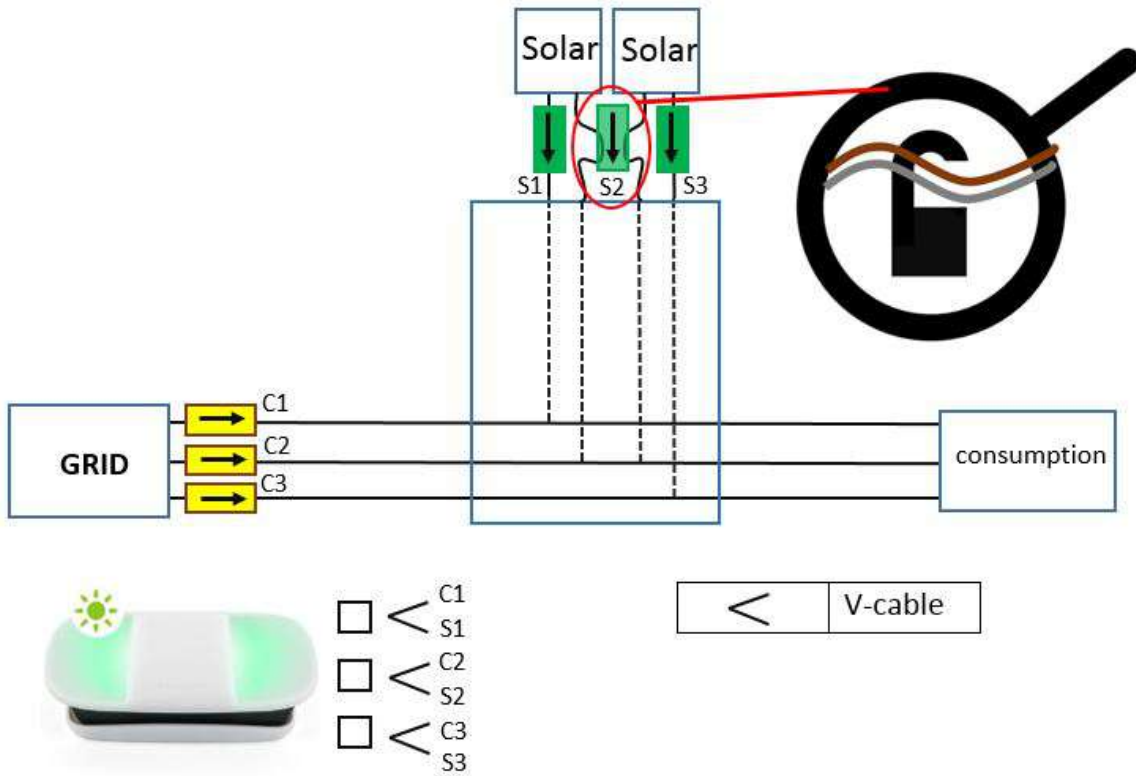

With 3 phase solar

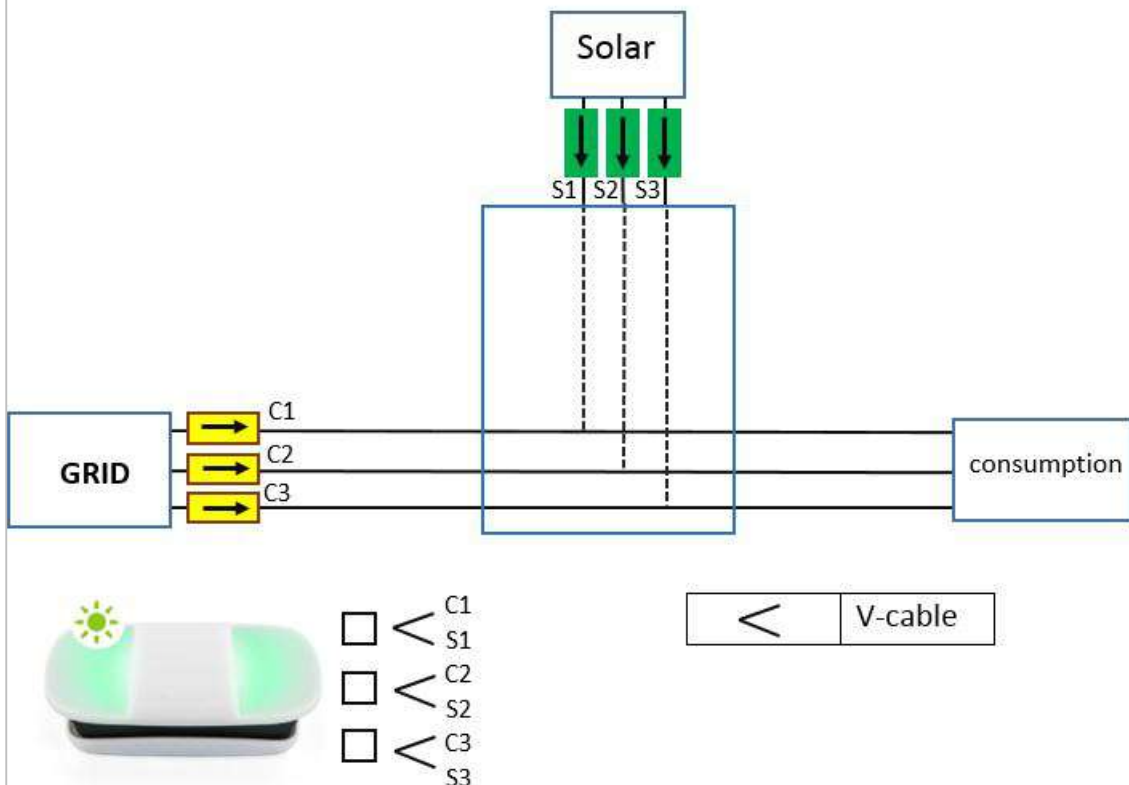

US Split Phase Installation Without Solar

Introduction

The following steps describe **the US split phase connection without solar panels.**

Instructions

Step 1: First please locate your fuse box and utility meter.

Step 2: Turn of the power and open up the fuse box. (you might need a screwdriver for this)



Step 3: You'll see 2 coloured wires coming from the utility meter. Ignore the blue/red wire (neutral wire) and any green/yellow wires (Grounding).



Step 4: The remaining wires are called the phase wires. They're usually grey, brown or black. In some installations other colours can be used for the phase wire.

Step 5: Take a current clamp and find the little arrow on the clamp.

Check for the symbol

L ← **K** in the clamp. The arrow shows the direction of the energy flow. Make sure that **L** points in the direction of the appliances (energy users) and **K** in the direction of the electricity meter.



Step 6: Place the current clamp over the brown (or phase) cable. Make sure that you properly close the clamp by pressing your thumb on the side until you hear a click. Please pay close attention to the direction of the arrow!



Step 7: Plug the ends of the current clamp cables into input 1 and 3 of the Smappee monitor.



Step 8: Now close the fusebox (be carefull not to jam the cable) and turn the power back on.

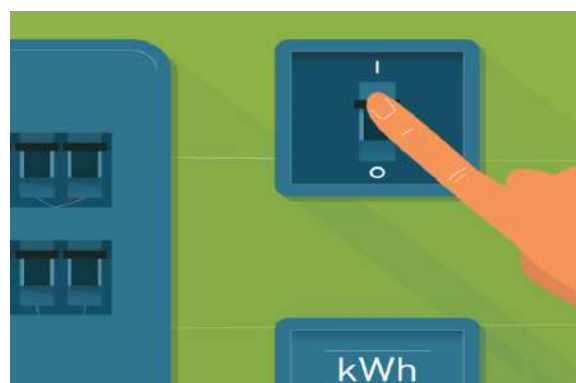

Step 9: Plug the power cord for the monitor into the wall socket and wait until the monitor shows a green heartbeat.

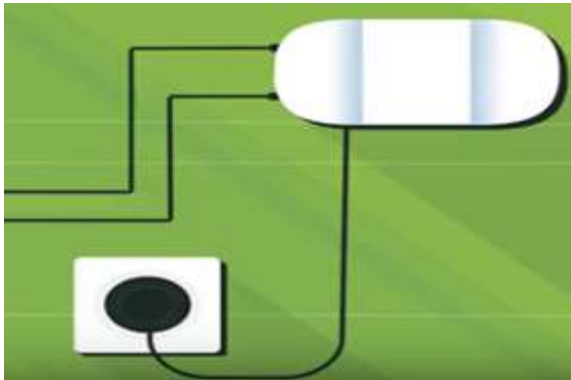

Step 10: You can now get started with the Smappee app.

US Split Phase Installation With Solar

Introduction

The following steps describe **the US split phase connection with solar panels.**

Instructions

Step 1: First please locate your fuse box and utility meter.

Step 2: Turn of the power and open up the fuse box. (you might need a screwdriver for this)



Step 3: You'll see 2 coloured wires coming from the utility meter. Ignore the blue/red wire (neutral wire) and any green/yellow wires (Grounding).



Step 4: The remaining wires are called the phase wires. They're usually grey, brown or black. In some installations other colours can be used for the phase wire.

Step 5: Take a current clamp and find the little arrow on the clamp. Check for the symbol **L ← K** in the clamp. The arrow shows the direction of the energy flow. Make sure that **L** points in the direction of the appliances (energy users) and **K** in the direction of the electricity meter.



Step 6: Place the current clamp over the brown (or phase) cable. Make sure that you properly close the clamp by pressing your thumb on the side until you hear a click. Please pay close attention to the direction of the arrow!



Step 7: Now locate the solar inverter and check the wires running to your fuse box. You'll see 2 phase wire which are usually black, brown or grey.

Step 8: Take a current clamp (CT) and clamp it around the phase wire with the little arrow on the clamps pointing away from the solar inverter. Make sure that you properly close the clamp by pressing your thumb on the side until you hear a click.

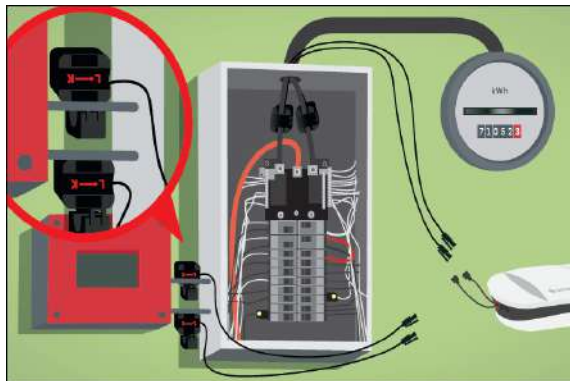

Step 9: Connect the V-cables to input 1 and input 3 of your monitor

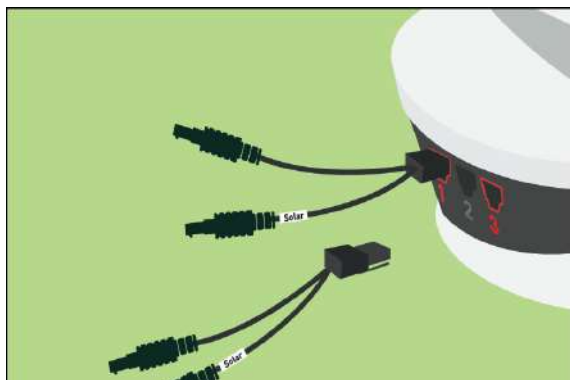

Step 10: Plug the cables of the clamps that are connected to your electrical installation in the unmarked legs of the V-cables. Please respect the polarity of the plugs!

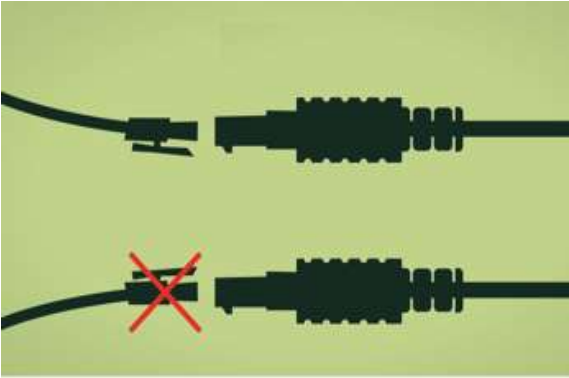
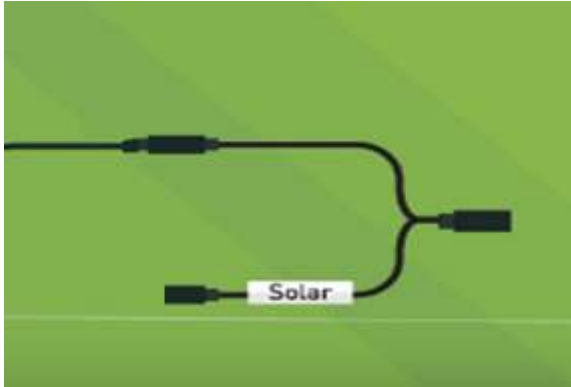

Step 11: Plug the cables of the clamps that are connected to your solar installation in the legs of the V-cables marked solar. Please respect the polarity of the plugs!

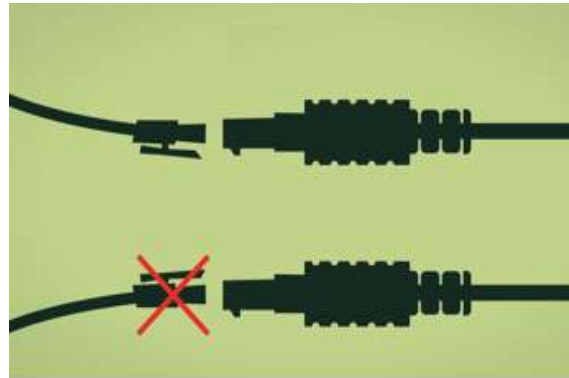
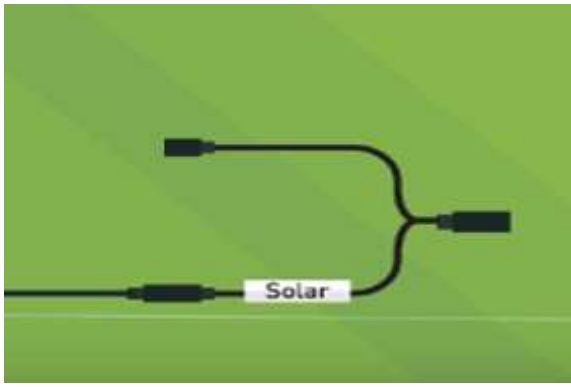

Step 12: Now close the fusebox (be carefull not to jam the cable) and turn the power back on.



Step 13: Plug the power cord for the monitor into the wall socket and wait until the monitor shows a green heartbeat.

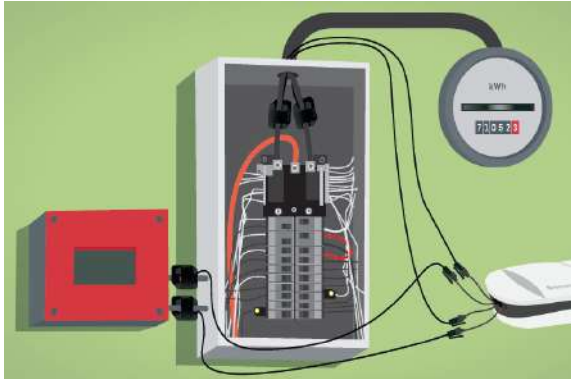

Step 14: You can now get started with the Smappee app.

Declaration of Conformity

October 5, 2013

We,

Smappee nv
Evolis 100
8500 Kortrijk
Belgium

following the provision of the following EC Directives:

- 2006/95/EC The Low Voltage Directive
- 2004/108/EEC The Electromagnetic Compatibility Directive
- 1999/5/EC R&TTE Directive

hereby declare that the product:

Smappee monitor-e1

is in conformity with the applicable requirements of the following documents

* Emissions:

Radiated Emission EN 55022 (Class B)
Conducted Emission EN 55022 (Class B)
EN 61000-3-2
EN 61000-3-3

* Immunity:

EN 55024
EN 61000-4-2
EN 61000-4-3
EN 61000-4-4
EN 61000-4-5
EN 61000-4-6
EN 61000-4-1

* Safety:

EN61010-1 Ed 3.0 (2010-06),

Authorized signatory



Hans Delabie
Chief Operating Officer