



A UTC Fire & Security Company

# UniFlame User Manual

## Unitized Detector Head & Amplifier

Publication 372000-48 Rev. H

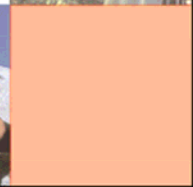
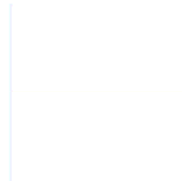
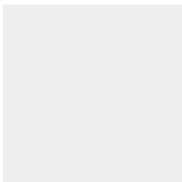
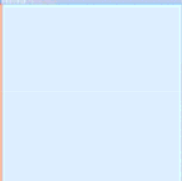
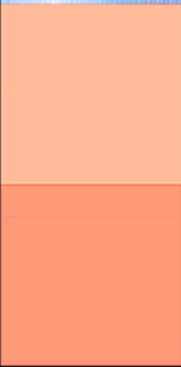

# UniFlame User's Manual

Unitized Flame Detector and Amplifier  
Infrared, Ultraviolet, and Multi-spectral Models

Publication 372000-48 Rev H



**NOTICE:** The equipment described in this manual was manufactured and sold under a contract containing limitations of manufacturer's liability for negligence and disclaimers of certain warranties. Installation or use of the equipment described in this manual constitutes an acceptance by the installer and user of those limitations and disclaimers. Copies of the contract may be obtained through any office of the manufacturer.

Copyright© 2009 Forney Corporation

## **INTRODUCTION**

This manual contains information for the UNIFLAME Flame Detector / Amplifier, provided by Forney Corporation, 3405 Wiley Post Road, Carrollton, Texas.

All personnel should become thoroughly familiar with the contents of this manual before attempting to operate or maintain the system. Because it is virtually impossible to cover every situation that might occur during operation and maintenance of the equipment described in this publication, personnel are expected to use good engineering judgement when confronted with situations that are not specifically mentioned herein.

The user should review this manual whenever significant changes are made to the system. To be of value, the manual must always reflect the latest configuration of the equipment. It should be noted, however, that Forney Corporation will furnish updated pages only if a modification is authorized by Forney and accomplished under Forney supervision.

## **PROPRIETARY NOTICE**

The contents of this publication are proprietary data of Forney Corporation. Reproduction or use of any part of the publication for purposes other than the support of the equipment for which it is published is permissible only if expressly authorized in writing by Forney.

The original source of this publication is Forney Corporation. Forney Corporation can not accept responsibility for the accuracy of any modifications made to this document subsequent to its issuance, except in the case where such modifications were made with the express written approval of Forney Corporation. All subsequent users of this publication should contact Forney Corporation to confirm the original contents of this publication.

Additional copies of this publication may be obtained from Forney. When ordering or requesting cost information, refer to the publication number appearing on the title page. Address to the attention of the Sales Department, Forney Corporation, 3405 Wiley Post Road, Carrollton, Texas 75006-5185.

**TABLE OF CONTENTS**

SECTION 1 Description ..... 1

    1.1 Operation ..... 1

    1.2 Application ..... 2

    1.3 Accessories ..... 2

    1.4 Features ..... 3

*Table 1-1 Agency Approvals* .....4

    1.5 Dimensions .....5

    1.6 Specifications .....5

SECTION 2 Installation Notes ..... 6

SECTION 3 Detector Wiring..... 8

    3.1 Grounding and Shielding Techniques ..... 9

    3.2 Quick Disconnect Layout ..... 10

    3.3 Wiring Harness Assembly Layout..... 11

SECTION 4 Remote Communications ..... 12

    4.1 Remote File Selection..... 13

SECTION 5 Programming UNIFLAME Series Detectors ..... 14

    5.1 Keypad/Display ..... 14

    5.2 UNIFLAME Menu Structure ..... 15

        5.2.1 STATUS LOOP.....15

            5.2.1.1 Status Points Defined.....16

        5.2.2 SETPOINT LOOP .....18

            5.2.2.1 AUTOTUNE Mode .....18

                5.2.2.1.1 AUTOTUNE Setpoints Defined .....19

            5.2.2.2 EDIT Mode.....20

                5.2.2.2.1 EDIT Mode Setpoints Defined.....21

SECTION 6 Self-Diagnostics ..... 24

SECTION 7 Storage ..... 25

SECTION 8 Warranty..... 25

SECTION 9 Return or Repair Service..... 25

SECTION 10 Spare Parts..... 26

*Table 2. Recommended Spare Parts List* .....26

---

## SECTION 1 DESCRIPTION

---

Forney's UNIFLAME Series flame detectors utilize micro-processor based technology combined with solid state infrared (IR), ultraviolet (UV), or dual (IR and UV) sensors. An adjustable flame relay resides in the body of the UNIFLAME Series flame detector, eliminating the need for a remote amplifier. The UNIFLAME Series flame detectors work on an amplitude and frequency (flame flicker) principle. The appropriate flicker frequency and amplitude gain is automatically configured in the AUTOTUNE mode or can be manually selected via the EDIT mode. Other features of the UNIFLAME Series flame detectors include automatic or manual adjustment of the flame relay ON and OFF Thresholds, 4-20 mA output, SPST flame relay, SPST fault relay, four remotely selectable program files, plus remote RS485 communications via Forney's Windows 95/98/NT based user software. All UNIFLAME detector models are powered by 24 Vdc, have a 12 pin electrical quick disconnect, contain electronic self-checking (no mechanical shutter) and are fully self diagnostic. The detectors contain an eight-character alpha-numeric LED display and a four (4) push-button keypad to enable the user to view operating parameters and configure setpoints.

### 1.1 OPERATION

The UNIFLAME Series flame detectors measure the amplitude of the modulating radiation that occurs within the targeted flame. During the detector set-up procedure, the modulation frequency that yields the best on and off discrimination is selected. The appropriate modulation frequency and sensor gain is either automatically selected or can be manually tuned. With the appropriate modulation frequency selected, the flame relay's ON and OFF Thresholds are automatically configured in the AUTOTUNE mode or can be manually adjusted in the EDIT mode. The detector's 4-20 mA Flame Quality output is at a minimum (4 mA) with a Flame Quality of "0", and at a maximum (20 mA) at a Flame Quality of "100".

The **FLAME RELAY** is energized (and its normally open contacts close) when the Signal Strength is at or above the programmed ON Threshold after the On Time Delay expires (OTD). The flame relay is de-energized when the Signal Strength is at or below the programmed OFF Threshold after the Flame Fail Response Time (FFRT) expires. The flame relay contact circuit will also open upon a power interruption or the detection of an internal fault.

The **FAULT RELAY** employs a de-energize to trip philosophy, in that the relay is energized when 24 Vdc is applied to the detector *and* when the detector successfully passed all internal self-checking routines. The fault relay is de-energized if there is a power interruption to the detector *or* if the detector has detected an internal fault (see Self Diagnostics Section 6). Internally, a normally open fault relay contact is wired in series with the flame relay contact.

**1.2 APPLICATION**

The **InfraRed Model** (P/N 401111-01) contains an infrared flame sensor, responding to wavelengths in the infrared range from 700 nm to 1700 nm. This sensor is best suited for all oil and coal fired applications.

The **UltraViolet Model** (P/N 401112-01) contains an ultraviolet flame sensor, responding to wavelengths in the ultraviolet range from 295 nm to 335 nm. This sensor is best suited for gas and light oil applications.

The **MultiSpectral Model** (P/N 401113-01) contains an infrared sensor as well as an ultraviolet sensor. Each respective sensor responds to wavelengths in the infrared range from 700 nm to 1700 nm and to wavelengths in the ultraviolet range from 295 nm to 335 nm.

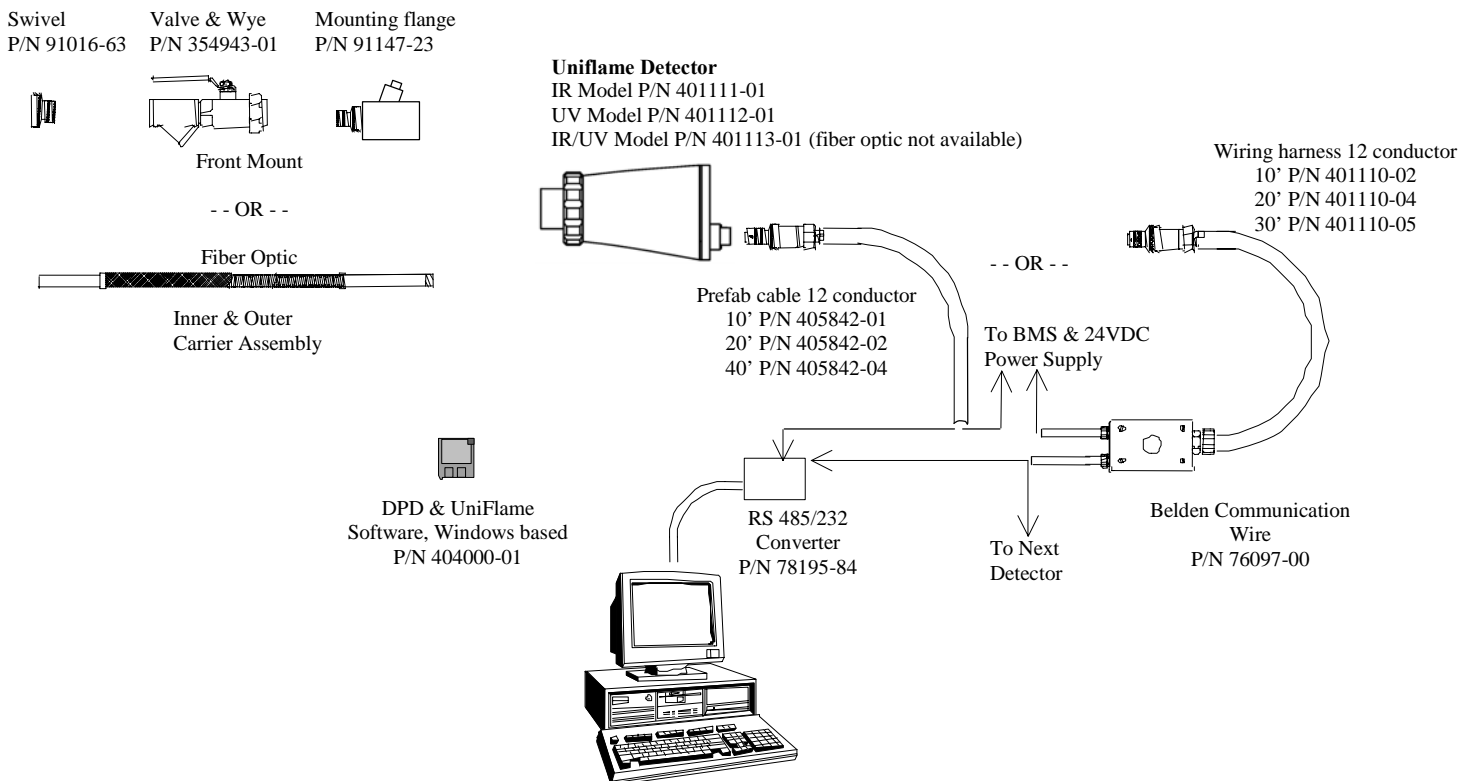

*Figure 1 – Application Drawing*

**1.3 ACCESSORIES**

Description	Part Number
12 Cond. Detector cable with factory installed female connector	405842-XX
Wiring harness assembly	401110-XX
10 Cond. Detector cable	91042-59
Swivel Mount	91016-63
Valve and Wye Assembly	352750-01
Power Supply (100VA)	79508-51

**1.4 FEATURES**

<b>Features</b>	<b>InfraRed Model</b>	<b>UltraViolet Model</b>	<b>MultiSpectral Model</b>
Infrared Sensor	√		√
Ultraviolet Sensor		√	√
Flame Relay	√	√	√
Fault Relay	√	√	√
4-20 mA output	√	√	√
Gain Adjust	√	√	√
Frequency Selections	√	√	√
Multiple Memory Files	√	√	√
Remote Communications	√	√	√
AUTOTUNE	√	√	√
Manual Tune	√	√	√
Local Display	√	√	√
Local Flame Sighting Indicator	√	√	√
Self Diagnostics	√	√	√
Self Check (electronic)	√	√	√
1 Sensor Signal Contribution	√	√	√
2 Sensor Signal Contribution			√

## Forney Corporation

**Table 1-1 Agency Approvals**

PART NUMBER	SENSOR	FEATURES	FIBER OPTIC MOUNT	12-PIN CONNECTOR	10 FT (3M) CABLE & GLAND	MAXIMUM CONTACT RATING	HOUSING RATING	AGENCY APPROVALS			
								UL C/US	FM	DIN-DVGW	CE
401101-01 401102-01 401103-01 ----- 401111-01 401112-01 401113-01	IR UV IR & UV ----- IR UV IR & UV	Basic  ----- Expanded	No	Yes	No	240 VAC	NEMA 4X IP66 CLASS I DIV 2 GROUPS A, B, C, & D CLASS II DIV 2 GROUPS F & G	Yes	Yes	No	No
401101-03 401102-03 401103-03 ----- 401111-03 401112-03 401113-03	IR UV IR & UV ----- IR UV IR & UV	Basic  ----- Expanded	No	No	Yes	240 VAC	NEMA 4X IP66 CLASS I DIV 2 GROUPS A, B, C, & D CLASS II DIV 2 GROUPS F & G	Yes	Yes	No	No
401101-02 401102-02 401103-02 ----- 401111-02 401112-02 401113-02	IR UV IR & UV ----- IR UV IR & UV	Basic  ----- Expanded	No	Yes	No	50 VAC	NEMA 4X IP66	No	Yes	Yes	Yes
401101-04 401102-04 401103-04 ----- 401111-04 401112-04 401113-04	IR UV IR & UV ----- IR UV IR & UV	Basic  ----- Expanded	No	No	Yes	240 VAC	NEMA 4X IP66	Yes	No	Yes	Yes
401105-01 401106-01 401107-01 ----- 401121-02 401122-02 401123-02	IR UV IR & UV ----- IR UV IR & UV	Basic  ----- Expanded	No	No (two internal 8-pole terminal blocks)	No	240 VAC	IP66 CENELEC EEXD IIC T6	No	No	No (see note)	No
401115-01 401115-03	UV	Expanded	Yes	Yes No	No Yes	240 VAC	NEMA 4X IP66 CLASS I DIV 2 GROUPS A, B, C, D CLASS II DIV 2 GROUPS F&G	Yes	Yes	No	No
401115-02 401115-04	UV	Expanded	Yes	Yes No	No Yes	50 VAC 240 VAC	NEMA 4X IP66	No	Yes	Yes	Yes
401123-04	IR & UV	Expanded	No	No	No	240 VAC	NEMA 4X IP66 EEXD IIC T6	No	No	Yes	Yes

*NOTE: The housing into which the CEX UNIFLAME electronics are installed has been approved by CENELEC and ATEX for use in EExd IIC T6 hazardous areas.*



**1.5 DIMENSIONS**

Housing Material: Die Cast Aluminum.  
 Finish: Silver Polyester Powder Coat

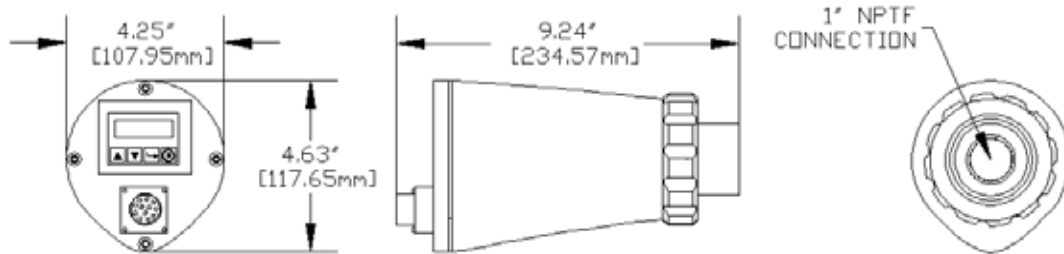

**Figure 2 – Dimensions**

**1.6 SPECIFICATIONS**

Agency Approvals:	See Table 1-1
<b>MECHANICAL:</b>	
Housing Material:	Die-cast Aluminum with Silver Polyester Powder Coat Finish
Housing Weight:	3.8 lbs (1.73 kg)
Environmental:	NEMA 4X, IP66
Mounting:	1" NPT female pipe mount secured with locking collar
Cooling/Purge Air Requirements:	
Source:	Clean, dry, cool
Volume:	Refer to submittal drawings.
Pressure:	6" w.c. (4.95 mbar) above furnace pressure
Temperature Rating:	-40°F to +150°F (-40°C to +65°C)
Humidity:	0% to 95% relative humidity, non-condensing
<b>ELECTRICAL:</b>	
Input Power:	24 Vdc, +10%, -15%
Supply current:	0.35 A
Electrical Connection:	12-pin, quarter-turn quick-disconnect
Relay Output:	Flame Relay, SPST (N.O. contacts) Fault Relay, SPST (N.C. contacts)
Contact Rating:	
Minimum:	10 mA @ 5 Vdc
Maximum:	2 A @ 240 Vac (resistive) 2 A @ 30 Vdc (resistive)
Analog Output:	4-20 mA dc current, referenced to 24 Vdc, max. connected load is 750 ohms.
Status Indication:	Eight (8) character, alpha numeric LED Display (scrolling capability)
Operator Interface:	Four (4) pushbutton style keys
Cable Specification:	Multi-core, 12 conductor (color coded), with overall braided shield. Six #18 AWG and four #22 AWG conductors, plus one #22 AWG twisted conductor pair. Cable Jacket: Irradiated Modified Polyolefin outer jacket (flame retardant, low smoke, zero halogen). Nominal O.D.: 0.45" (11.4 mm); Max O.D.: 0.47" (11.9 mm) Max cable length: 1000 feet (305 meters)

**SECTION 2 INSTALLATION NOTES**

The detector should be mounted so that the primary combustion zone is within the detector's line of sight. The primary combustion zone from a flame emits the majority of the frequency spectrum used by the detector to determine the presence or absence of the flame. The location and procedure listed below are general guidelines for the location of the detector if Forney's Burner Redline Review service is not utilized.

1. The best results are obtained when the detector is aimed so that the detector's line of sight intersects the burner center at a slight angle (e.g. 5 degrees) and sees a maximum of the primary combustion zone as shown in Figure 3.

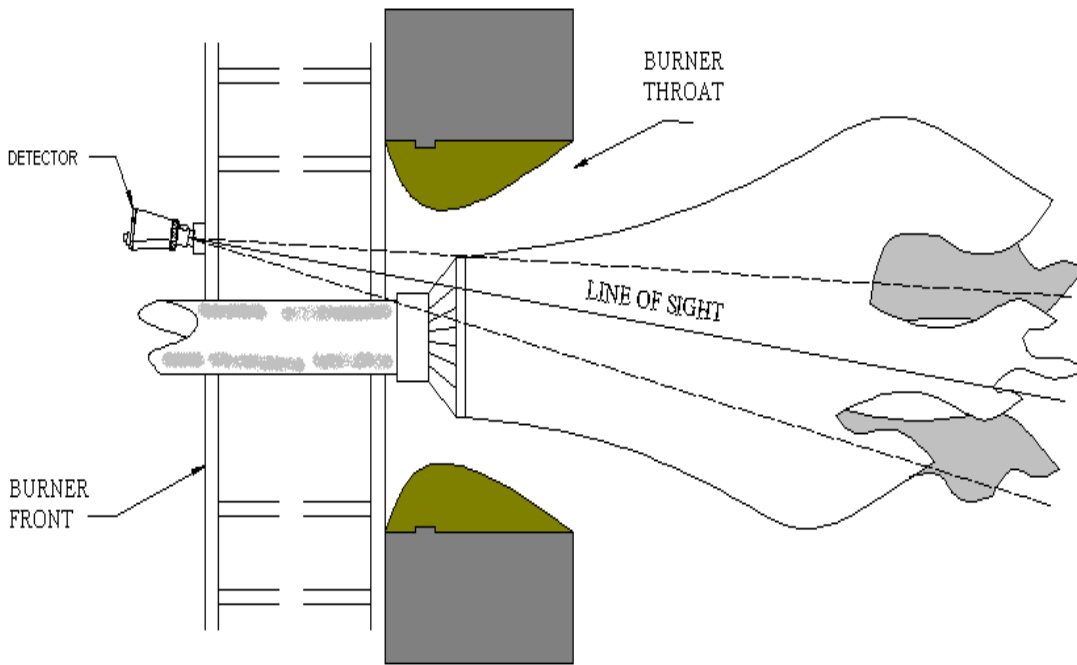

*Figure 3 - Line of Sight Installation*

2. The detector should have an unrestricted view of the flame as far as possible. Physical obstructions such as air register blades, spin vanes, or other hardware should not fall within the detector's line of sight as shown in Figure 4.



*Figure 4 - Flame View*

3. Consideration must be given to burner secondary air rotation, some burners have clockwise (CW) air rotation and others have counter clockwise (CCW) air rotation. If combustion air enters the furnace with a rotational movement of sufficient velocity to deflect the igniter flame in the direction of rotation, position the detector 10 to 30 degrees downstream of the igniter as shown in Figure 5 and close to the periphery of the burner throat. On opposed fired burners, avoid sighting main flame detector with igniter on opposite wall, i.e., 3 o'clock igniter with 9 o'clock main flame detector and mirror-image burner on the opposite wall.

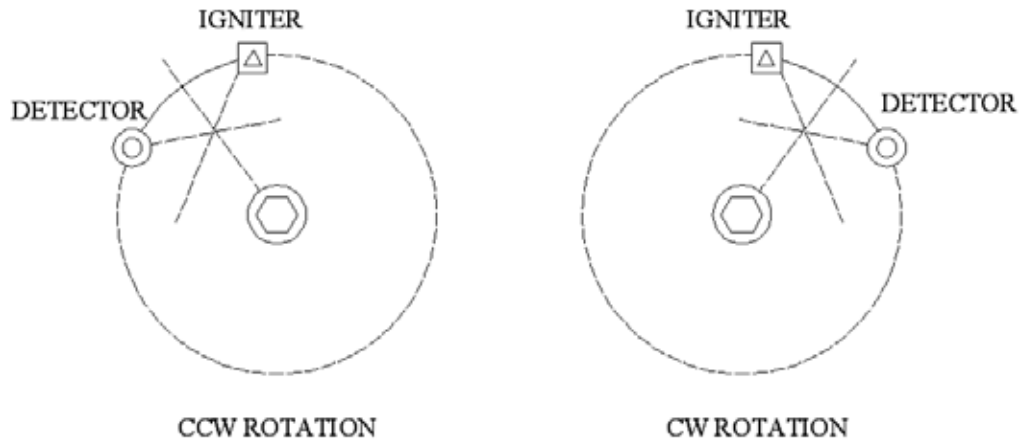

**Figure 5 – Air Rotation**

4. A minimum sight tube diameter of 2 inches is desired for optimal view of a flame through a 4-foot windbox. Use no more than one foot of one-inch diameter sight pipe. Increase the sight pipe diameter one inch for every additional 2 feet of sight pipe length used to avoid restricting the detector's field of view.
5. For ease of use, the detector should be installed on a sight pipe, so the LED display can easily be read. Please note that the operation of the LED display is independent of position.
6. The detector lens must be kept free of contaminants (oil, ash, soot, dirt) and the detector housing temperature must not exceed its maximum rating of 150°F (65°C). Minimum cooling air requirements for each detector are listed on the project submittal drawings. If cooling air is not available from the plant, Forney's dual blower assembly with automatic failover logic can be offered.
7. Please note, the real time internal detector temperature and maximum recorded temperature is available via the LED display.

**SECTION 3 DETECTOR WIRING**

All wiring to the detector should be rated at 90°C. For runs less than 1000 feet, the use of Forney detector cable P/N 405842-XX is recommended. For runs in excess of 1000 feet, please consult the factory. To reduce the electrical noise interference, the detector cable should be installed in rigid or flexible conduit. Take precautions to keep the detector cable away from any high inductive wiring associated with high inductive loads or high voltage / high energy spark ignition systems.

Because the UNIFLAME Series flame detectors require 24 Vdc power for operation, connection of a 24 Vac, 120 Vac, or 220 Vac power source will damage the detector. Therefore, external 2.0 Amp fuses are recommended to protect the processor flame relay and the fault relay contacts. See Figure 6.

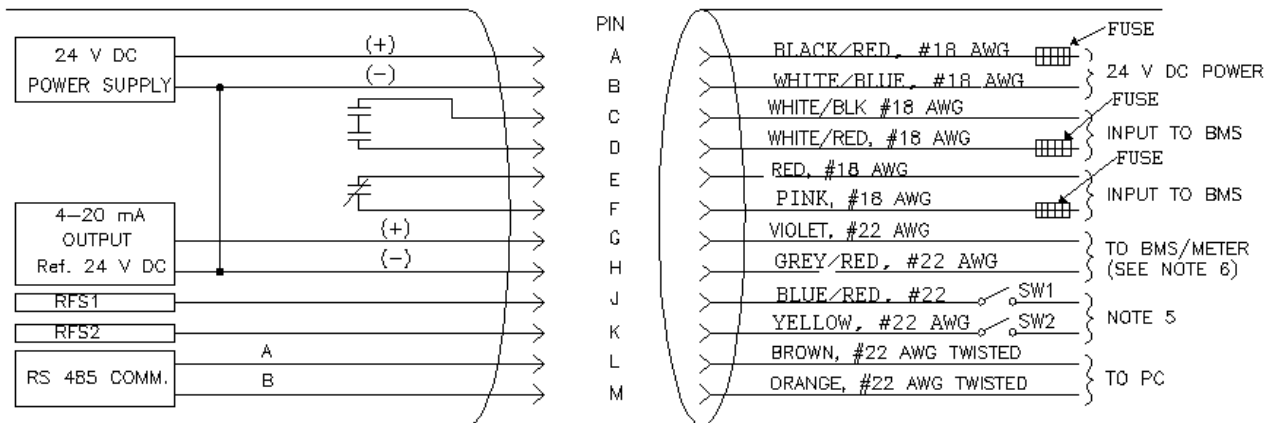

**Figure 6 - Cable Connection**

**Notes:**

1. Flame relay contacts are shown in the de-energized (no flame) condition.
2. Fault relay contacts are shown in the de-energized (fault) condition.
3. Brown and orange wires are a twisted pair.
4. Cable shield not shown.
5. With Remote File Select programmed as "LINE", external switches SW1/SW2 (not furnished) will select between four internal memory files, when connected to 24 Vdc (-) supply (see Section 4.1).
6. External 2.0 Amp fuses recommended.

### 3.1 GROUNDING AND SHIELDING TECHNIQUES

FOR USE ON DETECTORS OR DETECTOR CABLE LOCATED WITHIN 12 INCHES OF A HIGH ENERGY OR HIGH VOLTAGE SOURCE.

1. The detector and cable (preferably in flexible conduit) *must* be located at least 12 inches from the ignition source.
2. Run a ground wire from the ignition transformer chassis to the igniter assembly.
3. Replace all frayed, cracked, or dirty/oily ignition wires. Ignition wire must be in good working condition.
4. Electrically isolate the detector from the burner using the surface mounting flange provided.
5. Attach drain wire of the detector cable to earth ground of power supply.
6. For remote communications **less than 200 feet**, connect drain wire of the communication cable to earth ground of power supply.

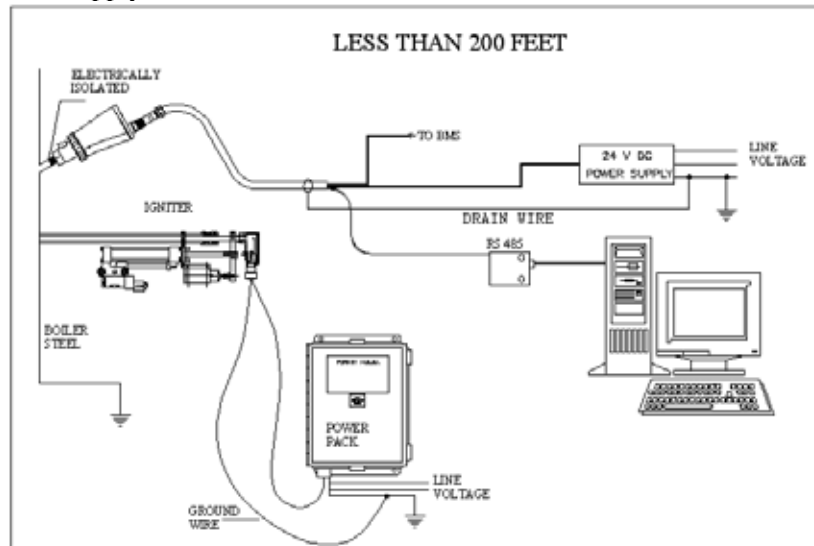

*Figure 7 – Connection for Less Than 200 Feet*

7. For remote communications **greater than 200 feet**, connect drain wire of the communication cable to earth ground of the RS485 source (e.g. IBM compatible computer).

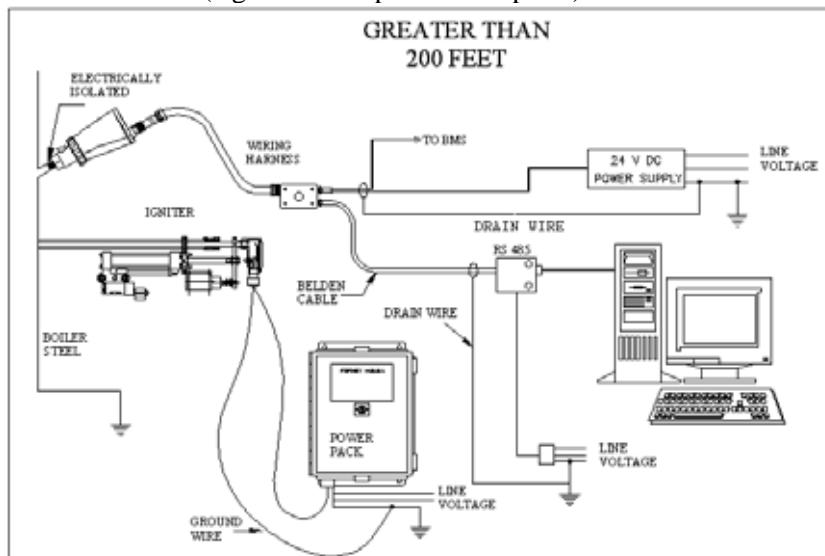

*Figure 8 – Connection for Greater Than 200 Feet*

**3.2 QUICK DISCONNECT LAYOUT**

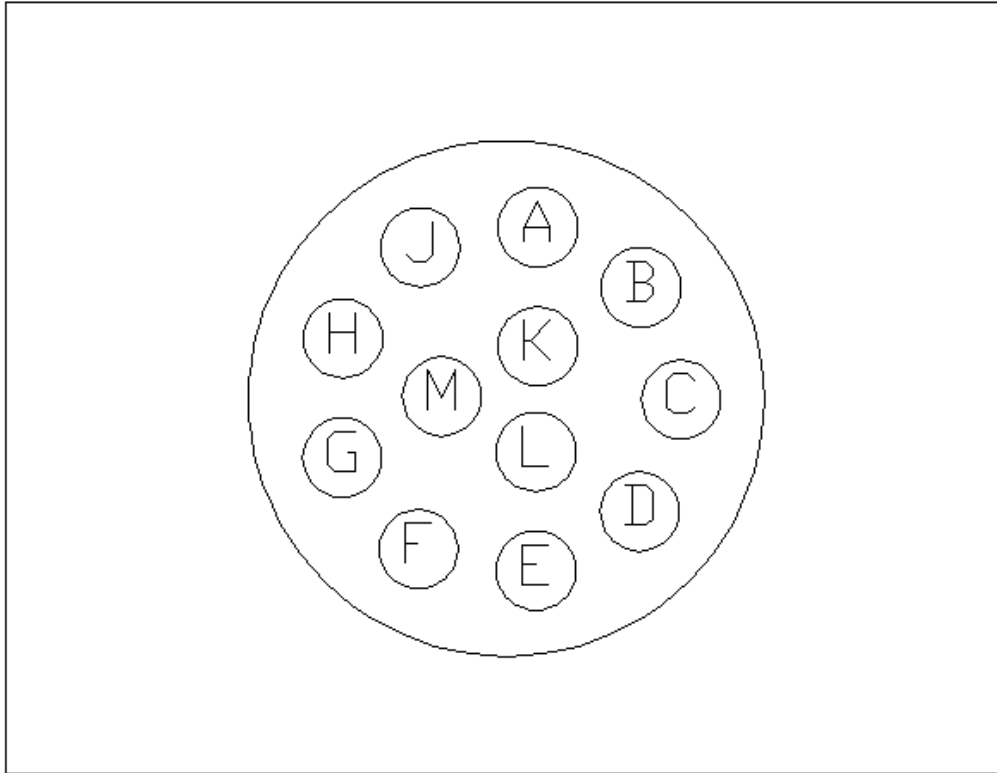

*Figure 9 – Quick Disconnect Layout*

Wire Color	Pin Designation	Function
Black/Red	A	Power (+) 24 Vdc
White/Blue	B	Power (-) 24 Vdc
White/Black	C	Flame Relay (N.O. contacts)
White/Red	D	Flame Relay (N.O. contacts)
Red	E	Fault Relay (N.C. contacts)
Pink	F	Fault Relay (N.C. contacts)
Violet	G	4-20 mA (+)
Grey/Red	H	4-20 mA (-)
Blue/Red	J	Remote File Select 1 (RFS1)
Yellow	K	Remote File Select 2 (RFS2)
Brown	L	Communications A (COMM A)
Orange	M	Communications B (COMM B)

**Note:** Brown and orange wires are a twisted pair.

### 3.3 WIRING HARNESS ASSEMBLY LAYOUT

To provide a service point at the burner front or an easy method to wire the UNIFLAME Series flame detectors in a “multi-drop” configuration for remote communications, Forney offers a wiring harness in four different lengths (10, 15, 20, 30 Ft.). The harness has a pre-wired female quick disconnect to plug into the male quick disconnect on the detector. The other end of the wiring harness has a NEMA 4 conduit box with a 16 point terminal strip. Twelve (12) wires are pre-wired to the female quick disconnect. The remaining four (4) terminals are used to “daisy-chain” the remote communication wires from one detector to another.

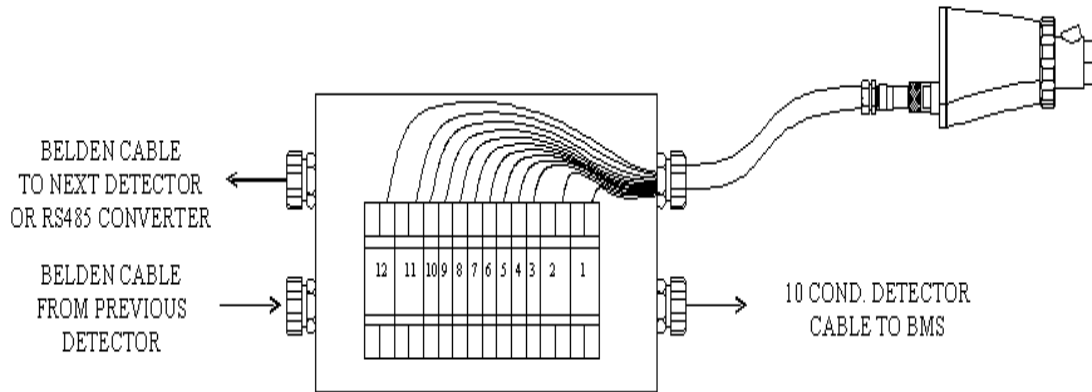

Figure 10 – Wiring Harness Assembly Layout

Cable	Wire Color	Terminal	Function	Termination
Detector Cable	Black/Red	1	Power (+) 24 Vdc	Back to the Control Room (To BMS)
	White/Blue	2	Power (-) 24 Vdc	
	White/Black	3	Flame Relay (N.O. contacts)	
	White/Red	4	Flame Relay (N.O. contacts)	
	Red	5	Fault Relay (N.C. contacts)	
	Pink	6	Fault Relay (N.C. contacts)	
	Violet	7	4-20 mA (+)	
	Grey/Red	8	4-20 mA (-)	
	Blue/Red	9	Remote File Select 1 (RFS1)	
	Yellow	10	Remote File Select 2 (RFS2)	
	Brown	11	Communications A (COMM A)	
	Orange	12	Communications B (COMM B)	
Belden Cable	Black	11	Communications A (COMM A)	To next Detector
	Clear	12	Communications B (COMM B)	
Belden Cable	Black	11	Communications A (COMM A)	To next Detector
	Clear	12	Communications B (COMM B)	

**SECTION 4 REMOTE COMMUNICATIONS**

Remote Communications with the UNIFLAME Series flame detector uses an RS485 Interface to carry out communications with an IBM compatible PC running Forney's SMARTDisplay Software. The wiring configuration for remote communications is dependent on the distance between the detector and the PC.

For distances **less than 200 feet**, Figure 11, run the cable directly back to the burner management system. For wiring distances **greater than 200 feet**, Figure 12, wire the twisted shielded pair of wires in a "multi-drop" wiring configuration, and then use a terminating resistor at the detector located farthest from the communication source.

The maximum distance for the communication wiring for all associated UNIFLAME Series detectors is 4,000 feet. The maximum number of detectors connected to the communication link is 32 detectors. Exceeding this total wiring length or number of detectors may require the installation of bi-directional repeaters or amplifiers. Consult the factory for additional details.

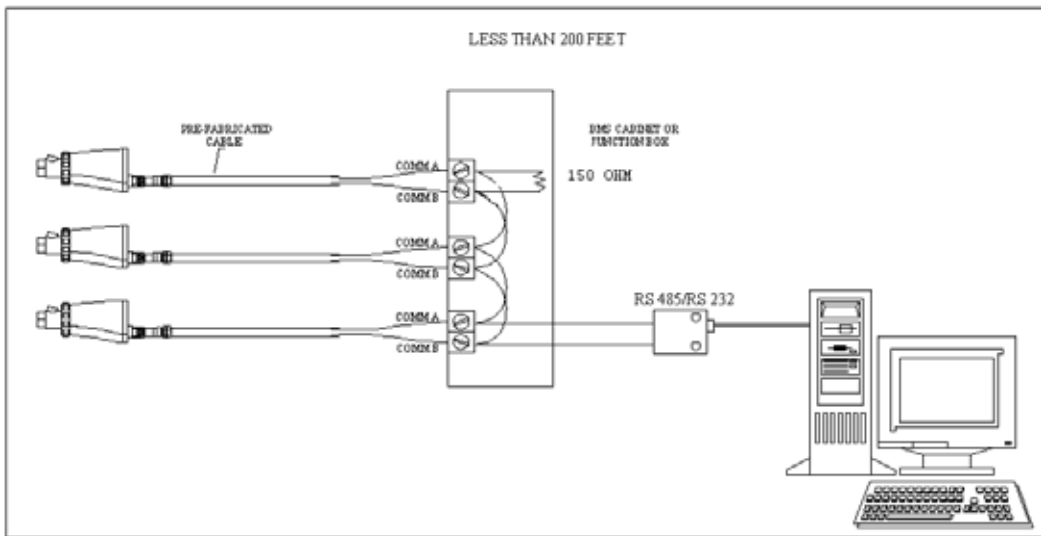

*Figure 11 – Remote at less than 200 feet*

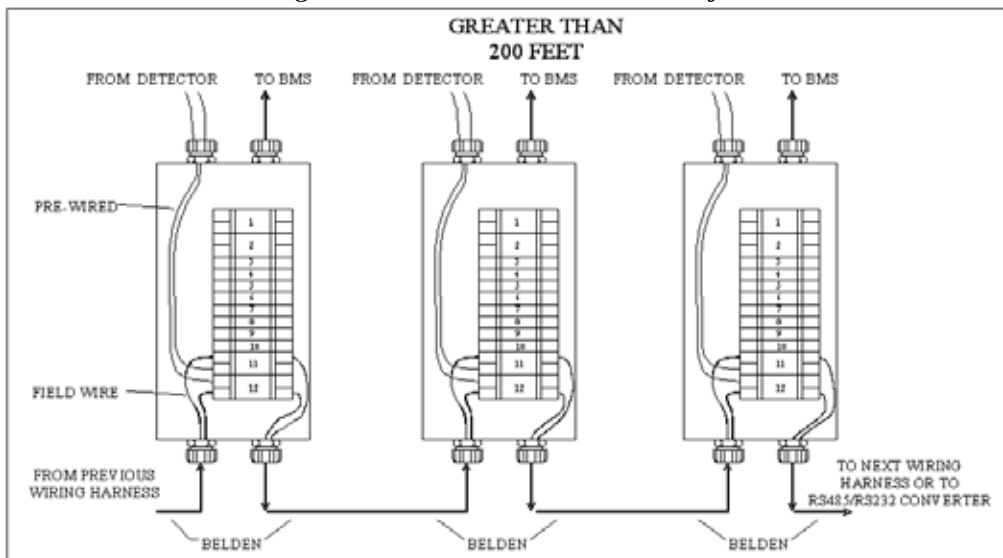

*Figure 12 – Remote at greater than 200 feet*



### 4.1 REMOTE FILE SELECTION

The UNIFLAME Series flame detectors have more than one internal memory file. The user has the option of storing different detector setpoints for different operating conditions (e.g. gas/oil, pilot/main, low load/high load, etc.) in these files. Each detector has four (A, B, C, and D) programmable files. With RFS selected as "LINE", one or two external switches (user supplied) will select between the files when RFS1 or RFS2 wires are connected to 24 Vdc (-).

RFS1 (Blue Wire – Pin J)	RFS2 (Yellow Wire – Pin K)	File Selected
Open	Open	A
Closed	Open	B
Open	Closed	C
Closed	Closed	D

The user may also select RFS as "KEY" which will allow manual file selection at the detector keypad, or select "COMM" which will allow manual selection at a remote computer running the Forney SMARTDisplay Software.

Forney recommends the use of a shielded cable for the two Remote File Select switches or relays. The contacts should be rated for low current operation at 3 mA dc. Relays for file switching are supplied by others, unless specified under a Forney Corporation system's project.

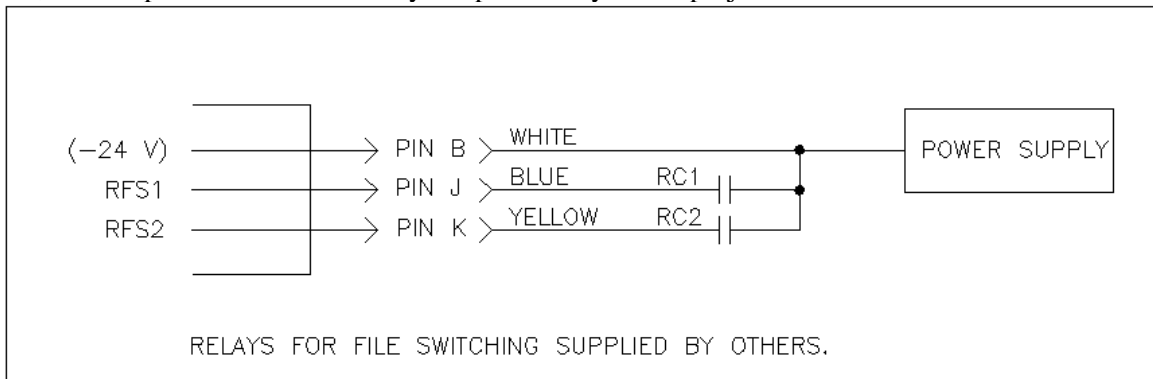

**Figure 13 – Remote File Selection**

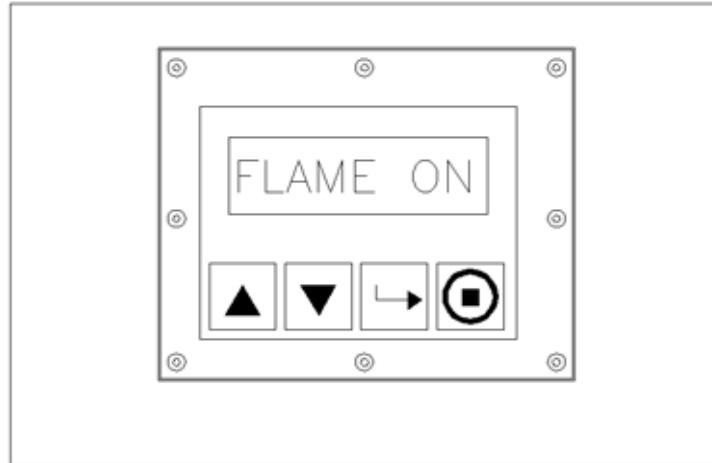

**SECTION 5 PROGRAMMING UNIFLAME DETECTORS**

**5.1 KEYPAD/DISPLAY**



*Figure 14 – Keypad/Display*

The UNIFLAME Series detectors use an eight (8) character alphanumeric LED display and four (4) push buttons (Figure 14) to review and program various setpoints and operating parameters. The functions of the push buttons are:

<p><b>Up Down keys</b></p>		<p>Use UP and DOWN keys to scroll through the detector's menus. When in the EDIT mode use the UP and DOWN keys to change the selected setpoint.</p>
<p><b>Select key</b></p>		<p>When in the EDIT mode, press the SELECT key to display the stored value of the setpoint. Use the UP/DOWN keys to change the value. Press the SELECT key a second time, although a setpoint has been changed, to return to the menu without saving the setpoint (except for parameters described in Section 5.2.2)</p>
<p><b>Program key</b></p>		<p>The PROGRAM key saves a change made to a setpoint. Use the PROGRAM key to execute the AUTOTUNE mode.</p>

## 5.2 UNIFLAME MENU STRUCTURE

For ease of operation, the UNIFLAME Series detectors contain 2 menu loops, STATUS LOOP and SETPOINT LOOP, that can be viewed and/or accessed via the keypad/display.

### 5.2.1 STATUS LOOP

The STATUS LOOP menu loop is the default loop and appears as soon as power is applied to the detector. Use the UP and DOWN keys to scroll through the menu and view the current operating status. No operating parameters can be changed from the STATUS LOOP. To change any setpoint, a four-digit password must be entered prior to entering the EDIT or AUTOTUNE modes. A summary of the text displayed in the STATUS LOOP is provided below and shown in Figure 15.

TEXT DISPLAYED	DESCRIPTION	POSSIBLE VALUES
FQ 0	Flame Quality (detector output)	0-100
FLAME ON	Flame relay status	ON, OFF
T=46C	Present detector temperature	-40°F to 185°F (-40°C to 85°C)
File A	Detector file in operation	A, B, C, D
i0 u0	Signal Strength, IR and/or UV	i = 0-999, u = 0-999
COMM 0	Communication address	0-127
SOFTWARE REV	Detector software revision	
MAX 56C	Max stored detector temperature	-40°F to 185°F (-40°C to 85°C)
PASSWORD	Entryway of password	(see password defined)
EDIT*	Entryway for EDIT mode	(see setpoint loop)
AUTOTUNE*	Entryway for AUTOTUNE mode	(see setpoint loop)

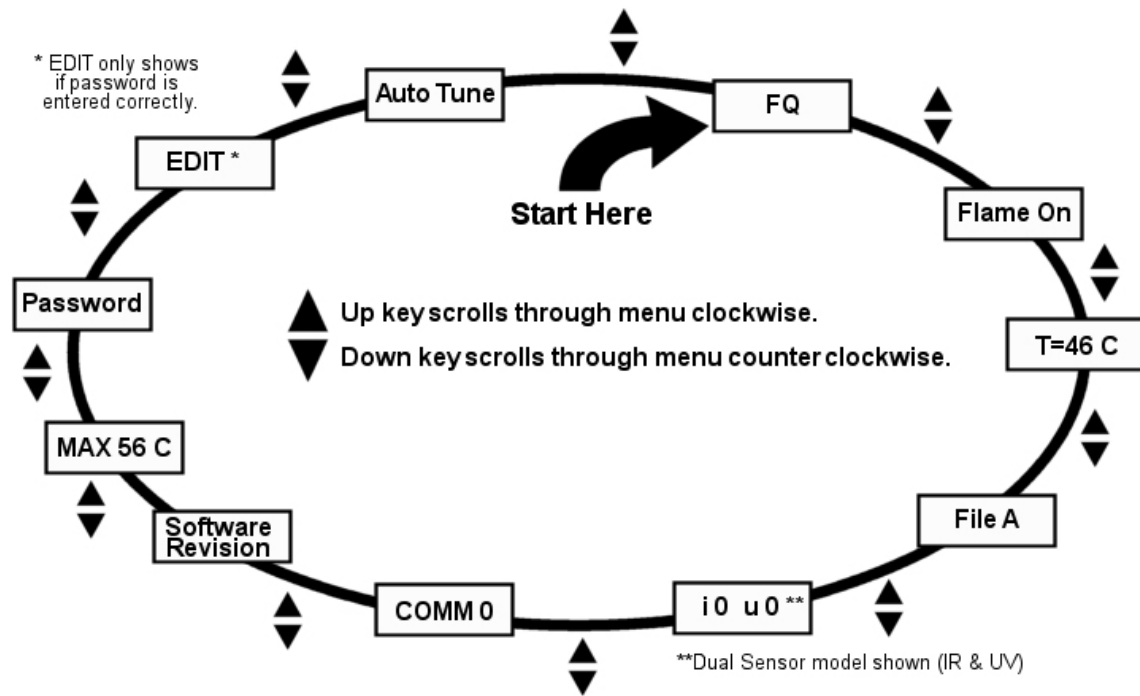

Figure 15 – Status Loop

### 5.2.1.1 STATUS POINTS DEFINED

#### **Flame Quality**

The Flame Quality number can range from 0 to 100. The number represents the detector's 4-20 mA analog flame Signal Strength output in percent. The Flame Quality is the scale by which the internal flame relay's ON and OFF Thresholds are configured.

The Flame Quality number is determined by the input of the IR or UV sensor. In the MultiSpectral model, the Flame Quality can also be configured to be the sum of the UV and IR sensors.

#### **Flame ON/OFF**

This item refers to the energized or de-energized status of the flame relay. "Flame ON" is displayed when the Flame Quality rises to or above the relay "ON Threshold" configured under the EDIT mode. When the Flame Quality drops to or below the relay "OFF Threshold", "Flame OFF" will be displayed.

#### **Temperature**

The detector's current internal temperature is expressed in either Fahrenheit or Centigrade depending on how the scale was configured in the EDIT mode.

#### **File Selected**

The current running file is displayed. Choices are A, B, C, or D.

#### **Signal Strength**

The Signal Strength number represents the intensity of the "Bandpass", as sensed by the IR and/or UV sensor(s). The number is a function of the individual sensor's "Gain" and "Bandpass" settings.

#### **Comm Address**

This number refers to the remote communications address of the flame detector. The address can range from 0 to 127, as configured in the EDIT mode. No two detectors in a communication loop should have the same address.

#### **Software revision**

This value identifies the internal software revision used.

#### **Maximum Temperature**

This value indicates the highest detector temperature recorded.

#### **Password**

A four-digit password is required to enter the EDIT and AUTOTUNE modes. If a password is not entered, pressing the UP key will advance directly to the "Flame Quality" status point.

The entry of a valid password will cause the EDIT mode to appear the next time the UP key is pressed and the AUTOTUNE mode to appear the second time the UP key is pressed.

*The factory-installed password is 0205.*

The following is a programming example using the factory password (example will not work if factory password was previously changed):

1. With "PASSWORD" displayed, press SELECT. "0xxx" appears, where the first digit shown is adjustable via the UP/DOWN keys.
2. With the appropriate first digit selected, press PROGRAM to confirm the value and move on to the next digit ("00xx"). Press the UP key twice to change the value from a 0 to a 2.
3. With the appropriate second digit selected, press PROGRAM to confirm the value and move on to the next digit ("020x").
4. With the appropriate third digit selected, press PROGRAM to confirm the value and move on to the next digit ("0200"). Press the UP key five times to change the value from a 0 to a 5.
5. With the appropriate fourth digit selected, press PROGRAM to confirm the value (0205).

If the password was not entered correctly, the display will read "Wrong Password". Press SELECT to re-enter the password.

If the password was entered correctly, the display will read, "Valid Password. Press SELECT to Change Password." If you wish to change the password, press the SELECT key and "0xxx NEW" will be displayed. Use the same programming method in previous example to enter any new four-digit password. Once complete, the display will read "New Password ####" (where #### is the new number entered). Press the UP or DOWN to return to the STATUS LOOP.

*Entering the correct password allows the user a 20 minute access time to the EDIT or AUTOTUNE modes. Changing any setpoint will restart the 20 minute time-out period.*

**5.2.2 SETPOINT LOOP**

The SETPOINT menu loop consists of the AUTOTUNE and EDIT modes. The AUTOTUNE mode allows the detector's processor to automatically tune the setpoints based on the appropriate target flame and background flame data, while the EDIT mode allows the user to manually configure the tuning setpoints.

**5.2.2.1 AUTOTUNE MODE**

From the AUTOTUNE mode, the user views the flame signal intensity and physically aims the detector for optimum signal. The user then commands the UNIFLAME Series flame detectors to analyze the target flame's ON and OFF (background radiation) conditions. The detector will then automatically select the optimum setpoints. The automatic selections of optimum setpoints include the appropriate sensor gain, bandpass frequency, sensor range and flame relay ON and OFF thresholds.

The AUTOTUNE mode is entered from the STATUS LOOP by first entering a four digit password. A summary of the text displayed in the EDIT mode is provided below and shown in Figure 16.

TEXT DISPLAYED	TEXT DISPLAYED (SELECT KEY)	POSSIBLE VALUES (UP/DOWN KEYS)
Aim Detector	I0 U0	0 to 60 (10 – 26 is best)
Learn On	Run Flame at Lowest setting and press PROGRAM	WAIT 128-0 (Counts down to 0 within 20 seconds, then displays "Learn ON complete")
Learn Off	Turn Flame OFF and press PROGRAM	WAIT 128-0 (Counts down to 0 within 20 seconds, then displays "Learn OFF complete")
--Exit--	Autotune (Returns to STATUS LOOP)	

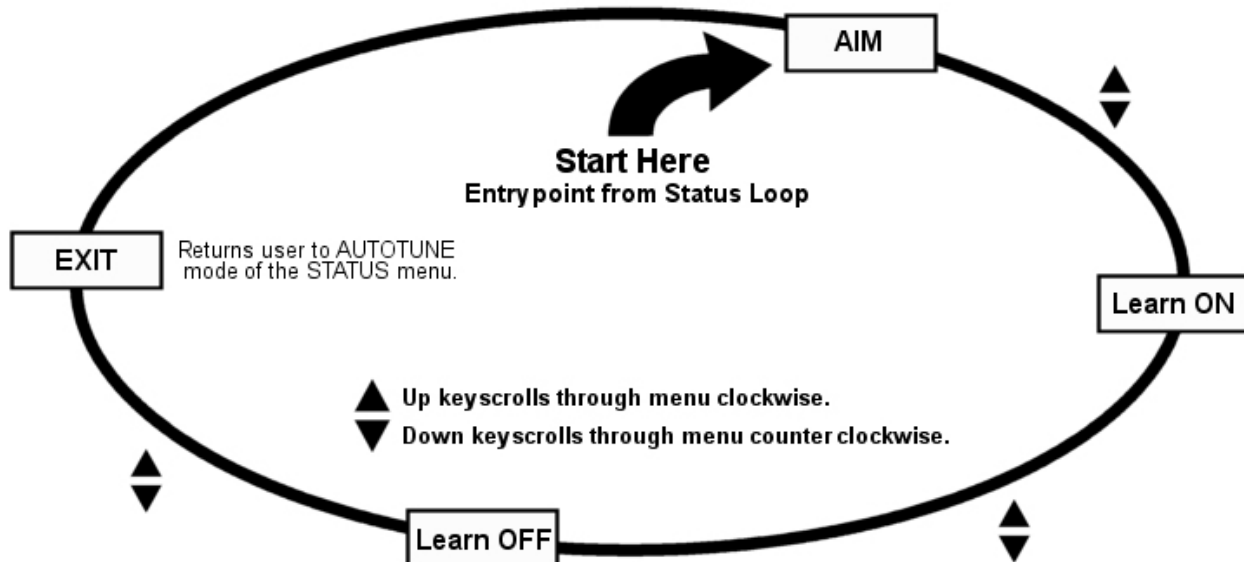

*Figure 16 – AUTOTUNE Mode*

### 5.2.2.1.1 AUTOTUNE SETPOINTS DEFINED

#### Aim Detector

Pressing the SELECT key causes, "Ix Ux" to appear (MultiSpectral Models only). The value of "x" may range from 0 to 60. The value displayed represents the intensity of the flame for the entire band (flicker frequency spectrum) as individually sensed by the IR (Ix) sensor and/or UV (Ux) sensor(s).

The numbers should be at their peak (highest numerically) when the detector is aimed at the primary combustion zone (first 1/3) of the flame. *If the detector is equipped with both an IR and UV sensor, priority should be given to maximize the UV intensity.*

Run the flame at a low firing rate and observe the signal level. Maximize the intensity reading if signals are low by adjusting the swivel mount or the detector's sighting. (Allow the detector to stabilize two seconds after each movement.)

If the reading is 10 or less, the intensity is marginal. Verify that the appropriate sensor "Range" parameter (IR Range or UV Range) in the EDIT Mode is set to "High" (see IRRange or UVRange in EDIT mode section).

If the reading is greater than 26 (the number will blink), the signal is excessive. Verify that the appropriate sensor "Range" parameter (IR Range or UV Range) in the EDIT Mode is set to "Low" (see IRRange or UVRange in EDIT mode section).

#### Learn ON

Run the flame at a normally operational low flame condition (e.g. low load, low O<sub>2</sub>) and press the PROGRAM key. The detector will display "Wait" followed by a number that will count down from 128 to 0 in about 20 seconds. This will temporarily store the spectrum of the monitored flame and adjacent flames. The front end gain number, used in the ON/OFF calculation, will be stored at this time.

#### Learn OFF

Turn off the monitored flame, leaving adjacent flames operating in a normally operational strong background condition (e.g. high load) and press the PROGRAM key. The detector will display "Wait", followed by a number that will count down from 128 to 0 in about 20 seconds. This will temporarily store the spectrum of the adjacent flames.

The "ON" spectrum will then be compared to the "OFF" spectrum and the frequency and gain for optimum discrimination will be selected.

The IR and UV gain settings will be automatically selected based on the proportionality of their flame ON:OFF ratios. In MultiSpectral models, the contribution of the IR and UV Signal Strengths to the Flame Quality is determined by the selection of their respective gain numbers. The gain settings will be selected to yield a total "Signal Strength" of between 100 and 150.

The flame relay ON and OFF Thresholds will be automatically set to 40 and 20, respectively, unless the "background" signal level is exceptionally high, which usually indicates poor aiming of the detector.

If, after learning Flame OFF, a sufficient on/off ratio was not found in at least one sensor, the display will show "Warning: Poor discrimination, try re-aiming the detector".

#### --EXIT--

Pressing the SELECT key will return the user to the AUTOTUNE mode in the STATUS LOOP.

**5.2.2.2 EDIT MODE**

The EDIT mode contains all the user-selected setpoints for the UNIFLAME Series detectors. The EDIT mode can be used to program the detector directly, or can be used to fine-tune the AUTOTUNE mode. The EDIT mode is entered from the STATUS LOOP after entering a four-digit password. In the EDIT mode, the user is allowed to change the setpoints to optimize the detector performance. A summary of the text displayed in the EDIT mode is provided in the following table and shown in Figure 17.

TEXT DISPLAYED	TEXT DISPLAYED (SELECT KEY)	POSSIBLE VALUES (UP/DOWN KEYS)
File Select	FILE A	A, B, C, D
Temperature Scale	Scale C	C, F
Comm Address	COMM 0	0-127
Remote File Select	RFS KEY	KEY, LINE, COMM
File Copy	A →	
Language	English	English
Sensors	UV + IR (MultiSpectral Model Only)	UV+IR, IR Only, UV Only
IR Band	i23/0 (IR frequency/Signal Strength)	23, 31, 39, 46, 54, 62, 70, 78, 85, 93, 101, 109, 117, 125, 132, 140, 148, 156, 164, 171, 179 Hz
IR Gain	IG31/0 (IR gain/Signal Strength)	1-31
IR Range	IRR High	High, Low
UV Band	u23/0 (UV frequency/Signal Strength)	23, 31, 39, 46, 54, 62, 70, 78, 85, 93, 101, 109, 117, 125, 132, 140, 148, 156, 164, 171, 179 Hz
UV Gain	UG31/0 (UV gain/Signal Strength)	1-31
UV Range	UVR High	High, Low
ON Threshold	ONT 40	5-100
OFF Threshold	OFFT 20	0-95
FFRT	FFRT 1	1, 2, 3, 4, 5, 6 seconds
OTD	OTD 1	1, 2, 3, 4, 5, 6 seconds
--EXIT--	Edit (Returns to STATUS LOOP)	

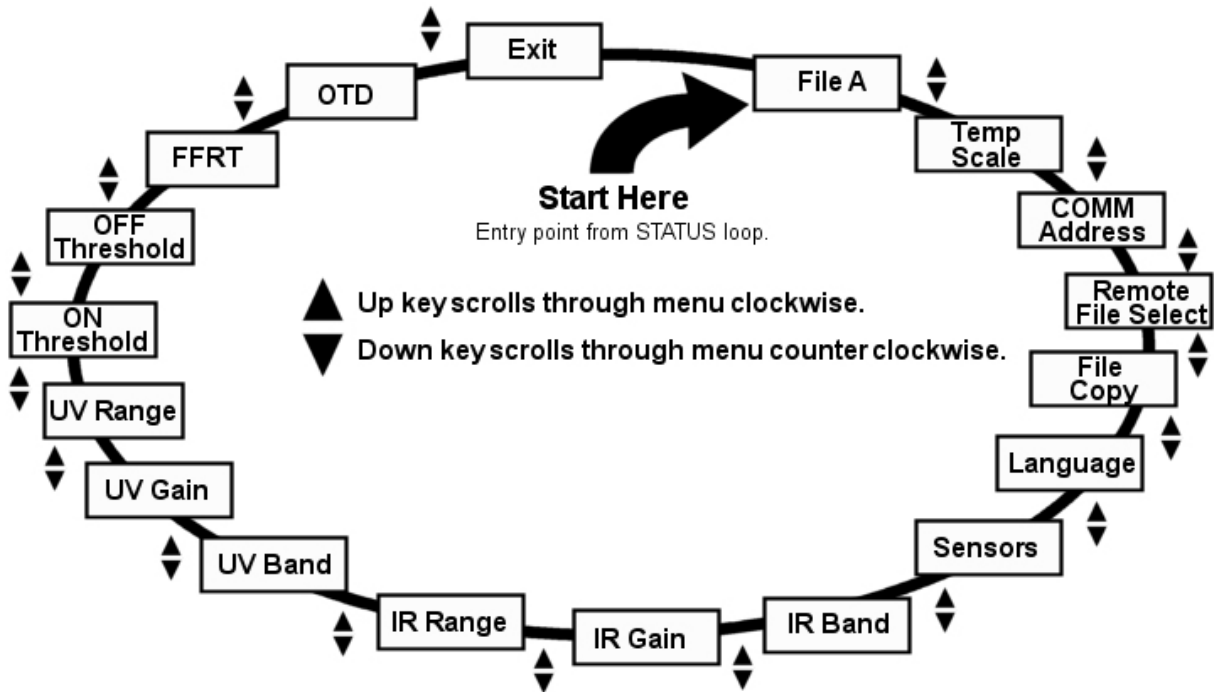

Figure 17 – EDIT Mode



### 5.2.2.2.1 EDIT MODE SETPOINTS DEFINED

#### File Select

The user can manually choose which file to run (and edit) by selecting this menu choice provided the Remote File Select “KEY” choice is selected. If the user wants to edit the contents of a file, they must first select and run that particular file.

#### Temperature Scale (Affects all files)

The scale may be configured for Fahrenheit (F) or Celsius (C).

#### Comm Address (Affects all files)

The communications address selected may range from 0 to 127. Each detector must have a unique address. No two detectors in a communication link can have the same address.

#### Remote File Select (Affects all files)

Choices are:

- **KEY** – allows the file selection to be made only at the keypad.
- **LINE** – allows the file selection to be made only via an external switch or relay.
- **COMM** – allows the file selection to be made only via an external computer running the Forney Smart Display Software.

#### File Copy

This function allows the user to copy the contents of one internal detector file to another. 4 user configurable files exist (A, B, C, D) and two factory configured files exist (F1, F2).

The factory-configured files (F1, F2) contain factory settings. For file (F1), the sensor gain is set at maximum (31) and the band (target flame flicker frequency) is set at 23 Hz. At these settings, the detector will respond to almost any flame, but will not discriminate between target flame and other nearby flames. For File (F2), the sensor gain is set at minimum (1) and the band is set at 70 Hz. At these settings, the detector will not respond to a flame unless the gain is increased.

A copy can be made *from* any file *to* a user file. A copy can not be made *from* a user file *to* a factory file. With “FileCopy” displayed, depress the SELECT key. The display will read “A→”, with “A” being the source file. Use the UP or DOWN keys to select a different source file (e.g. “F1→”).

With the desired source file displayed, press the PROGRAM key. The arrow will flash and the destination file will appear (e.g. “F1→A”). Initially the destination file displayed is “A”. Use the UP or DOWN keys to select the desired destination file (e.g. “F1→B”).

Press the PROGRAM key to copy the source file to the destination file. The display will read “File Copied”. (Pressing the SELECT key at any time before pressing the PROGRAM key for the second time will cancel the operation.) Press the UP or DOWN keys to scroll through the EDIT loop.

#### Language (Affects all files)

This allows the user to select which language the menu system will use. The available choice is “English”.

**Sensors** (MultiSpectral models only)

Choices include: UV only, IR only, or UV + IR. This parameter is used to manually select which sensor(s) are used in a particular file.

**IR Band**

The display is divided into two halves. The left side displays the selected IR flicker frequency bandpass (i23). The right side displays the Signal Strength (/999) attributed to the IR sensor.

For example a reading of i109/400, would indicate an IR band of 109 Hz with a corresponding Signal Strength of 400 is running. The band can range from 23 Hz to 179 Hz, while the Signal Strength can range from 0-999.

Pressing the UP or DOWN keys changes the frequency band displayed and immediately stores the value (pressing the PROGRAM key is not required). The user will immediately see the effect on the Signal Strength.

**IR Gain**

The display is divided into two halves. The left side displays the selected IR Gain (iG31). The right side displays the Signal Strength attributed to the IR sensor.

For example a reading of iG26/600, would indicate an IR gain of 26 with a corresponding Signal Strength of 600. The IR sensor Gain is selectable from 1(lowest) to 31 (highest), while the Signal Strength number can range from 0 to 999.

Pressing the UP or DOWN keys changes the gain displayed and immediately stores the value (pressing the PROGRAM key is not required). The user will immediately see the effect on the Signal Strength.

Each increment of the gain will increase the Signal Strength number for the IR sensor by 50% (e.g. changing IR sensor gain from 26 to 27 would increase the IR Signal Strength from 600 to 900).

Each decrement of gain will decrease the Signal Strength number for the IR sensor by 33% (e.g. changing IR sensor gain from 27 to 26 would decrease the Signal Strength from 900 to 600).

**IR Range**

There are two selectable internal "ranges" for the IR sensor Gain, "High" and "Low". If a flashing IR number is observed when "Aiming" the detector, then the signal is over range and the IR Range should be set to "Low". If, when "Aiming" the detector, an IR number of less than 10 is observed, then the IR Range should be set to "High".

**UV Band**

The display is divided into two halves. The left side displays the selected UV flicker frequency bandpass (u23). The right side displays the Signal Strength (/999) attributed to the UV sensor.

For example a reading of u109/400, would indicate an UV band of 109 Hz with a corresponding Signal Strength of 400. The band can range from 23 Hz to 179 Hz, while the Signal Strength can range from 0-999.

Pressing the UP or DOWN keys changes the frequency band displayed and immediately stores the value (pressing the PROGRAM key is not required). The user will immediately see the effect on the Signal Strength.

**UV Gain**

The display is divided into two halves. The left side displays the selected UV Gain (uG31). The right side displays the Signal Strength attributed to the UV sensor.

For example a reading of uG26/600, would indicate an UV gain of 26 with a corresponding Signal Strength of 600. The UV sensor Gain is selectable from 1 (lowest) to 31 (highest), while the Signal Strength number can range from 0 to 999.

Pressing the UP or DOWN keys changes the gain displayed and immediately stores the value (pressing the PROGRAM key is not required). The user will immediately see the effect on the Signal Strength.

Each increment of the gain will increase the Signal Strength number for the UV sensor by 50% (e.g. changing UV sensor gain from 26 to 27 would increase the UV Signal Strength from 600 to 900).

Each decrement of gain will decrease the Signal Strength number for the UV sensor by 33% (e.g. changing UV sensor gain from 27 to 26 would decrease the Signal Strength from 900 to 600).

**UV Range**

There are two selectable internal “ranges” for the UV sensor Gain, “High” and “Low”. If a flashing UV number is observed when “Aiming” the detector, then the signal is over range and the UV Range should be set to “Low”. If, when “Aiming” the detector, an UV number of less than 10 is observed, then the UV Range should be set to “High”.

**ON Threshold**

This refers to the “pull in” threshold of the internal flame relay, in terms of “Flame Quality”. The ON Threshold can be set from 5 to 100. The ON Threshold must be at least 5 units higher than the OFF Threshold.

When the Flame Quality is equal to or greater than the ON Threshold (for a time equal to the “On Time Delay” setting, see OTD below), the flame relay will energize.

**OFF Threshold**

This refers to the “drop-out” threshold of the internal flame relay, in terms of “Flame Quality”. The OFF Threshold can be set from 0 to 95. The OFF Threshold must be at least 5 units lower than the ON Threshold.

When the Flame Quality is equal to or less than the OFF Threshold (for a time equal to the “Flame Fail Response Time” setting, see FFRT below), the flame relay will de-energize.

**FFRT - Flame Fail Response Time**

When the Flame Quality drops to or below the flame relay OFF Threshold, the flame relay will de-energize after the selected value, ranging from 1 to 6 seconds. The maximum allowable FFRT setting is determined by local safety code, and is factory set at 1 second.

**OTD**

When the Flame Quality rises to or above the flame relay ON Threshold, the flame relay will energize after the selected value, ranging from 1 to 6 seconds.

**--EXIT--**

Pressing the SELECT key will return the user to the EDIT point in the STATUS LOOP.

## SECTION 6 SELF-DIAGNOSTICS

All UNIFLAME Series flame detectors are micro-processor based and are fully self diagnostic. A listing of self-diagnostic messages with corresponding troubleshooting techniques is outlined below:

Fault Code	Description	Action
1001 through 1027	RAM Failure	<ul style="list-style-type: none"> <li>Remove source of electrical interference.</li> <li>Verify regulated 24 Vdc on Pin A &amp; B.</li> <li>Re-power detector to see if fault clears.</li> <li>If not, replace detector.</li> </ul>
2001 through 2003	ROM Failure	<ul style="list-style-type: none"> <li>Remove source of electrical interference.</li> <li>Verify regulated 24 Vdc on Pin A &amp; B.</li> <li>Re-power detector to see if fault clears.</li> <li>If not, replace detector.</li> </ul>
3001 through 3003	EEPROM Failure	<ul style="list-style-type: none"> <li>Remove source of electrical interference.</li> <li>Verify regulated 24 Vdc on Pin A &amp; B.</li> <li>Re-power detector to see if fault clears.</li> <li>If not, replace detector.</li> </ul>
4001 through 005	CPU Failure	<ul style="list-style-type: none"> <li>Remove source of electrical interference.</li> <li>Verify regulated 24 Vdc on Pin A &amp; B.</li> <li>Re-power detector to see if fault clears.</li> <li>If not, replace detector.</li> </ul>
4101 through 4501	A-D Failure	<ul style="list-style-type: none"> <li>Remove source of electrical interference.</li> <li>Verify regulated 24 Vdc on Pin A &amp; B.</li> <li>Re-power detector to see if fault clears.</li> <li>If not, replace detector.</li> </ul>
5001 through 5201	Detector Failure	<ul style="list-style-type: none"> <li>Remove source of electrical interference.</li> <li>Verify regulated 24 Vdc on Pin A &amp; B.</li> <li>Re-power detector to see if fault clears.</li> <li>If not, replace detector.</li> </ul>
6001	Relay Failure	<ul style="list-style-type: none"> <li>Replace or send back to Forney for repair</li> </ul>
6002	Output Failure	<ul style="list-style-type: none"> <li>Replace or send back to Forney for repair</li> </ul>
6101	Voltage Failure	<ul style="list-style-type: none"> <li>Remove ground fault or electrical interference.</li> <li>Verify regulated 24 Vdc on Pin A &amp; B.</li> <li>Re-power detector to see if fault clears.</li> <li>If not, replace detector.</li> </ul>
6102	Fault Relay Failure	<ul style="list-style-type: none"> <li>Replace or send back to Forney for repair</li> </ul>
6201	Over Temperature Failure	<ul style="list-style-type: none"> <li>Fix cause for insufficient cooling air.</li> <li>Remove detector and allow to cool down.</li> <li>If detector still does not respond, replace detector.</li> </ul>
7000 through 7008	Program Sequence Failure	<ul style="list-style-type: none"> <li>Remove source of electrical interference.</li> <li>Verify regulated 24 Vdc on Pin A &amp; B.</li> <li>Re-power detector to see if fault clears.</li> <li>If not, replace detector.</li> </ul>

**Note:** Upon re-powering detector, the last fault message will be displayed. Press the UP or DOWN key to return to STATUS LOOP.

**SECTION 7 STORAGE**

---

Store the UNIFLAME detector in its shipping box until used. Refer to the mechanical specifications for storage temperature range.

**SECTION 8 WARRANTY**

---

Forney Corporation warrants this product to be free of defective material and workmanship. Forney will repair or replace this equipment if it is found to be defective upon receipt, but not later than 1 year (12 months) from the date of shipment.

**SECTION 9 RETURN OR REPAIR SERVICE**

---

Prior to returning any material to Forney, obtain a Return Material Authorization (RMA) identification number from Forney. Clearly mark the RMA number on all shipping containers and accompanying documents. Forney accepts only material submitted in accordance with the RMA instructions.

To issue an RMA, Forney must have the following information:

1. List of Equipment to be returned by stock number/model number
2. Reason for return
3. Company name and address of customer
4. Customer's requested mode for return shipping
5. Customer's purchase order number for repairs (if applicable)
6. Customer's requested return date
7. Name and address to which Forney is to return-ship and any special container marking information that may be required
8. Name of individual (customer's representative) requesting the RMA.

Any of the following methods may be used to obtain an RMA:

1. Phone: (972) 458-6100 OR (972) 458-6142  
1-800-356-7740 (24-hour line)  
Ask for the Customer Service  
Repair Department.
2. Fax: (972) 458-6600
3. Mail: Attn: Return Material  
Forney Corporation  
3405 Wiley Post Road  
Carrollton, Texas 75006-5185

**Forney Corporation is not responsible for materials returned without proper authorization and identification.**

Exercise care in packing the materials to be returned. The shipper will be advised of any damage due to improper packing; no further action will be taken in connection with this material return until the shipper provides clearance for further disposition.

**SECTION 10 SPARE PARTS**

The recommended spare parts list in Table 2 advises of the minimum stock level of replacement parts that should be in the customer's stock for system startup and the first year of operation. Replacement parts should be ordered as necessary to maintain the suggested stock of spare parts at the recommended level.

*Table 2. Recommended Spare Parts List*

Part Description	Part Number	Qty
Flame Detector	40111x-xx	10% of qty. required for boiler
Power Supply	79508-51	1 for every 5
12 Cond. Pre-fab Cable	405842-xx	1 for every 10
Wiring Harness	401110-xx	1 for every 10

When ordering spare parts, furnish the following information to:

Attn: Spare Parts Department  
 Forney Corporation  
 3405 Wiley Post Road  
 Carrollton, Texas 75006-5185

Phone: (972) 458-6100  
 1-800-356-7740 (24-hour line)  
 Ask for the Customer Service

Fax: (972) 458-6600

1. Contract number
2. Customer purchase order number
3. For each part ordered, provide the following information:
  - a. Part Number
  - b. Part Description
  - c. Quantity Required