

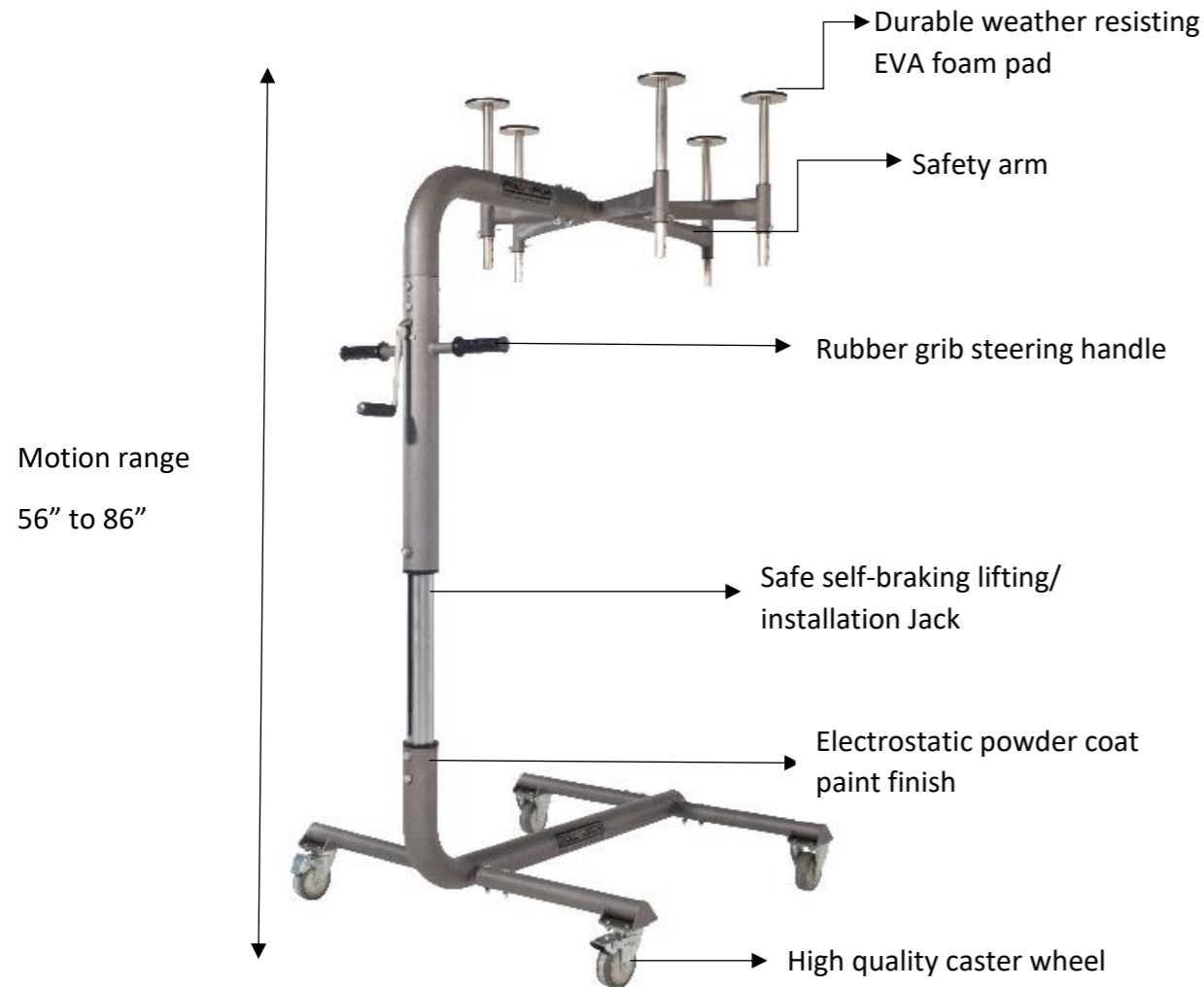

Light weight and portable Jeep hardtop removal system



READ ALL INSTRUCTIONS BEFORE ASSEMBLY AND USE OF ROLLN JACK

Please read all warnings, directions and watch related videos before attempting to install. If you are missing a part: DO NOT RETURN PRODUCT TO DEALER OR CALL DEALER. Call, leave a message or email us with your name, telephone number and address and we will send you the part you need. We are best reached at email: help@rollnjack.com

WARNINGS:

1. Always wear the appropriate safety gear when assembling the RollnJack.
2. IT IS NECESSARY TO ATTACH THE 5th SAFETY ARM TOP POSTS AFTER REMOVING THE HARTOP AWAY FROM THE VEHICLE. THIS IS FOR ALL 4 DOOR MODELS. FAILURE TO DO SO COULD RESULT IN SERIOUS INJURY OR EVEN DEATH. KEEP CHILDREN AWAY FROM THE ROLLN JACK WHEN IN STORAGE WITH HARDTOP.
3. NEVER – Push on the hardtop itself, Move the unit by pushing on the front or sides, Move unit in 100% raised position. Lower the unit to move to desired location.

Note: On 2 door models, the 5th safety arm top post does not have to be attached.

Usage instruction:

- Have RollnJack on level ground, with a smooth surface prior to top removal. A slight incline or decline can be acceptable.
- Remove both (2) Freedom Panels.
- Unscrew bolts on each side of hardtop near and above driver and passenger seats.
- Open cargo door and lift rear window ajar completely.
- Unscrew 6 Torx bolts that fasten hardtop in cargo area.
- DETACH electrical connection on driver side before removing hardtop.
- Enter the rear cargo on center with the RollnJack, making sure the 4 top posts just clear under window frame ridge.
- Turn the Easy Handle until 4 top posts engage top make sure it is secure. Turn the Easy Handle until you lift enough to clear alignment posts (black pins that align hardtop).
- Lift enough to clear alignment posts and rear gate when rolling backwards and clearing spare tire.
- THE ROLLN JACK IS A SELF BRAKING LIFT MECHANISM SO YOU CAN LET GO OF THE HANDLE ANYTIME AND IT WILL NOT DROP.



How to use RollnJack



RollnJack Assembly



For more products please visit



RollnJack Youtube Channel

THE ROLLN JACK ASSEMBLY INSTRUCTION

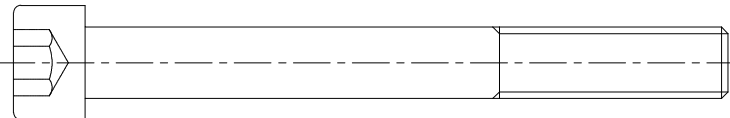
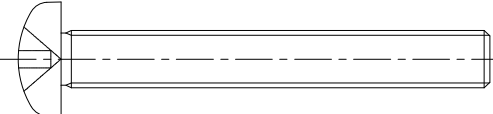
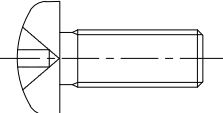
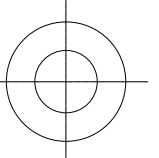
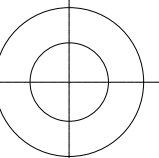
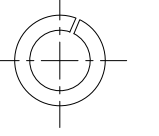
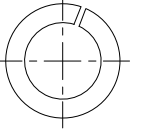
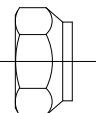
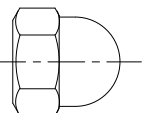
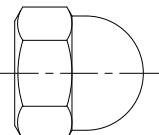
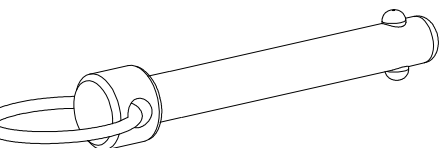
- A**  **M10x100 (6X)**
- B**  **M8x60 (8X)**
- C**  **M8x20 (16X)**
- D**  **M8-Flat (24X)**
- E**  **M10-Flat (6X)**
- F**  **M8-Lock (24X)**
- G**  **M10-Lock (6X)**
- H**  **M8-Nut (16X)**
- I**  **M8-Nut (8X)**
- K**  **M10-Nut (6X)**
- L**  **Ø8x60-Pin (5X)**

