

ESE 099-812 Finish Hand Seamer

Parts List

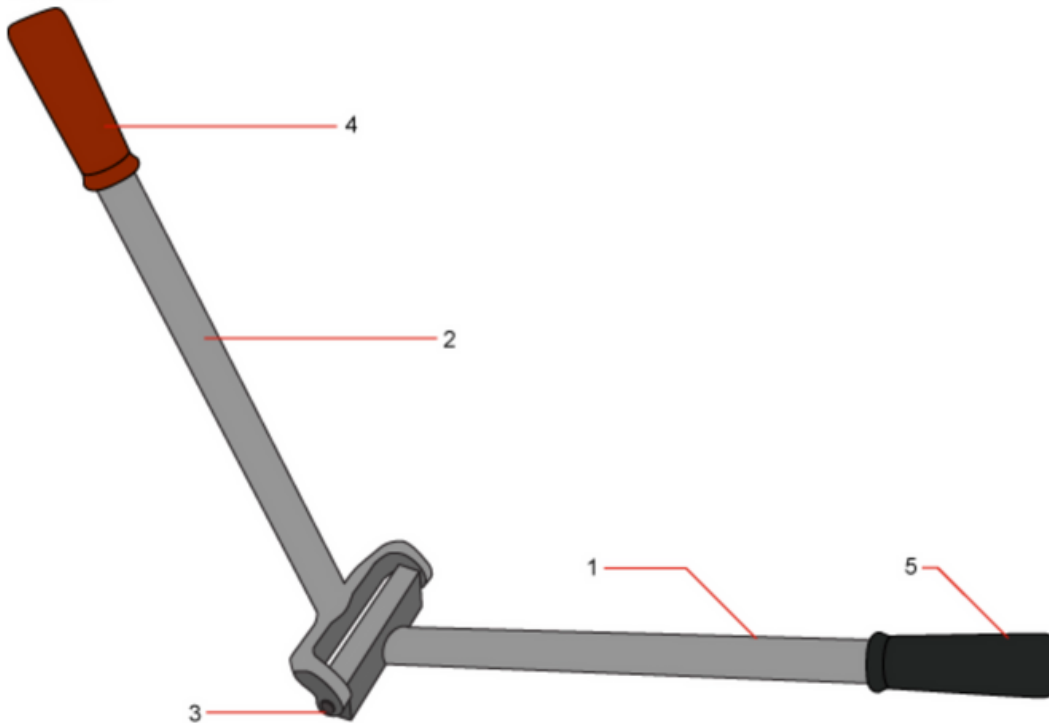

1	Angle and Angle Handle	099N-01
2	Pivot and Pivot Handle	099N-02
3	Dowel Pins (2)	099N-03
4	Round Grip (red)	099N-04
5	Round Grip (black)	099N-05

This tool cannot be disassembled. The red and black grips are the only parts that can be ordered.

All other parts shown are provided for reference.