

CONDO 303-3430
ST-CATHERINE

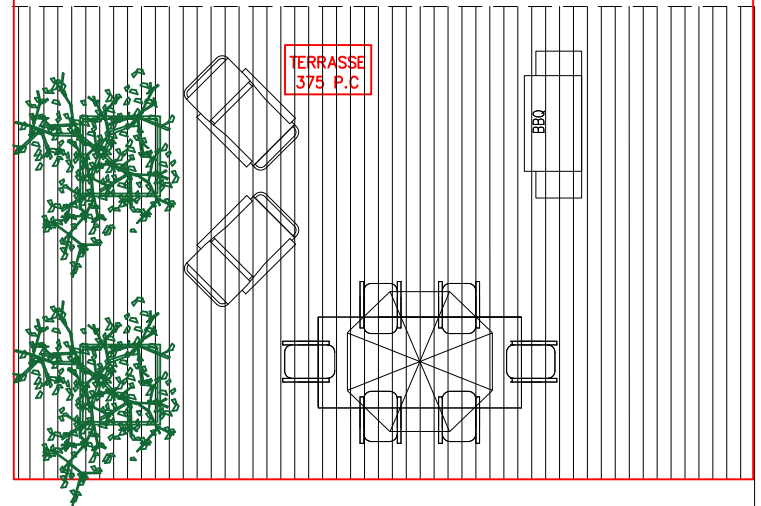

5 COMPRESSEURS

BATISSE EXISTANTE

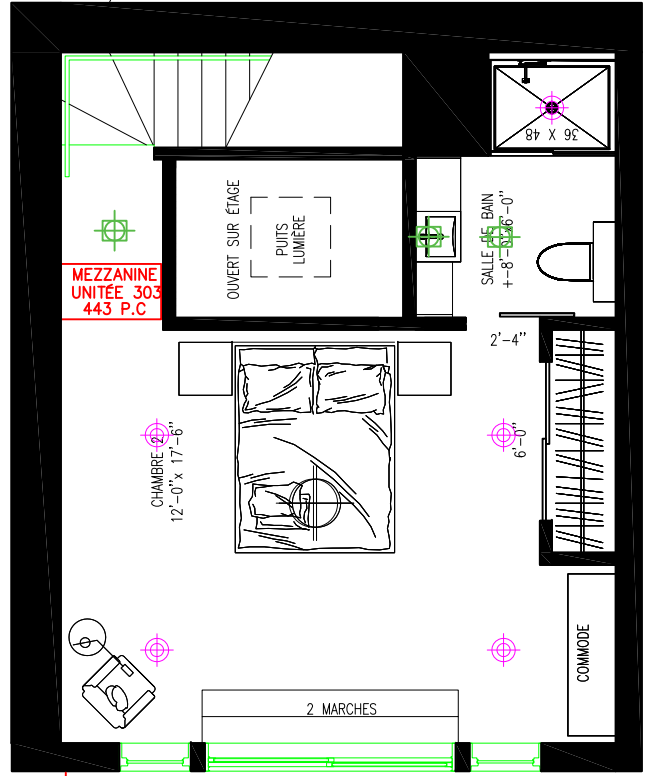
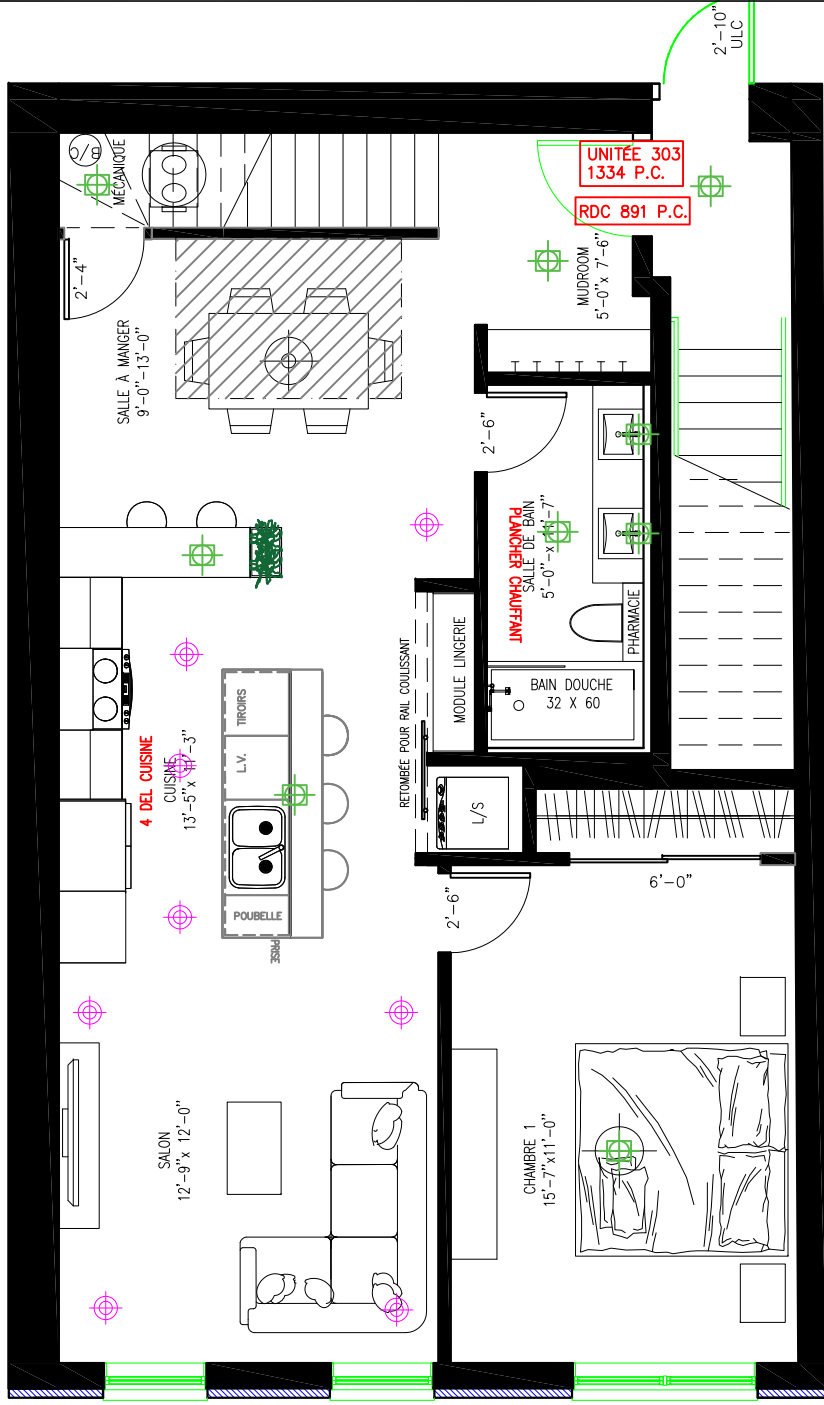
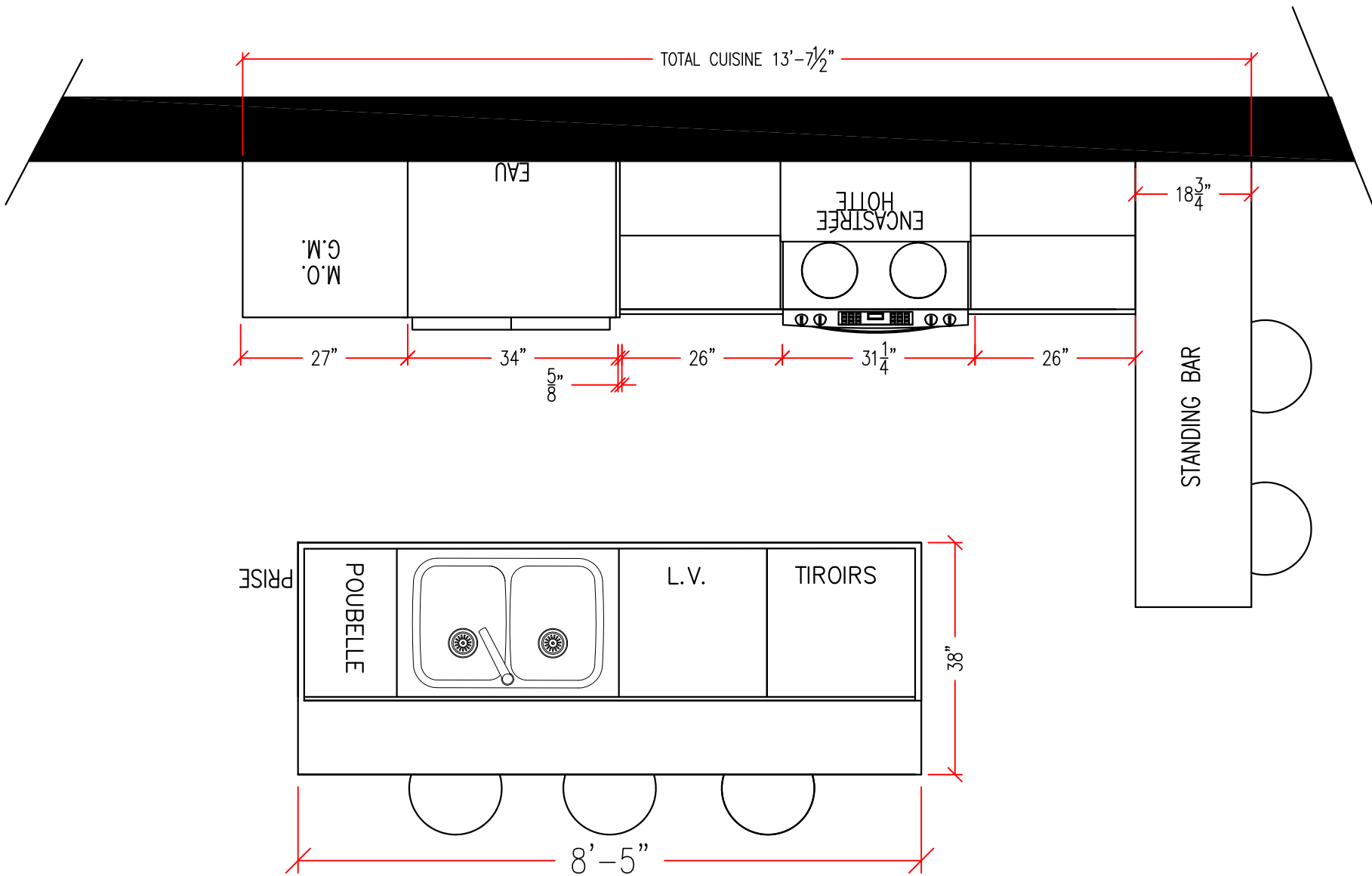

QUARTZ HORS CONTRAT
 DOSSERET STRATIFIÉ FINSA 17N PROFUNDO
 CACHE DUCT MÉLAMINE FISA 17N

THERMO BLANC 104
 MODÈLE 1000 F
 POIGNEÉS V0117-128 L24

PLAN CUISINE
 CONDO 303
 ST-CATHERINE

CONDO 303

CONDO 303

5 BAQUETTES DE BOIS 2" X 2"
COLLER AU MUR

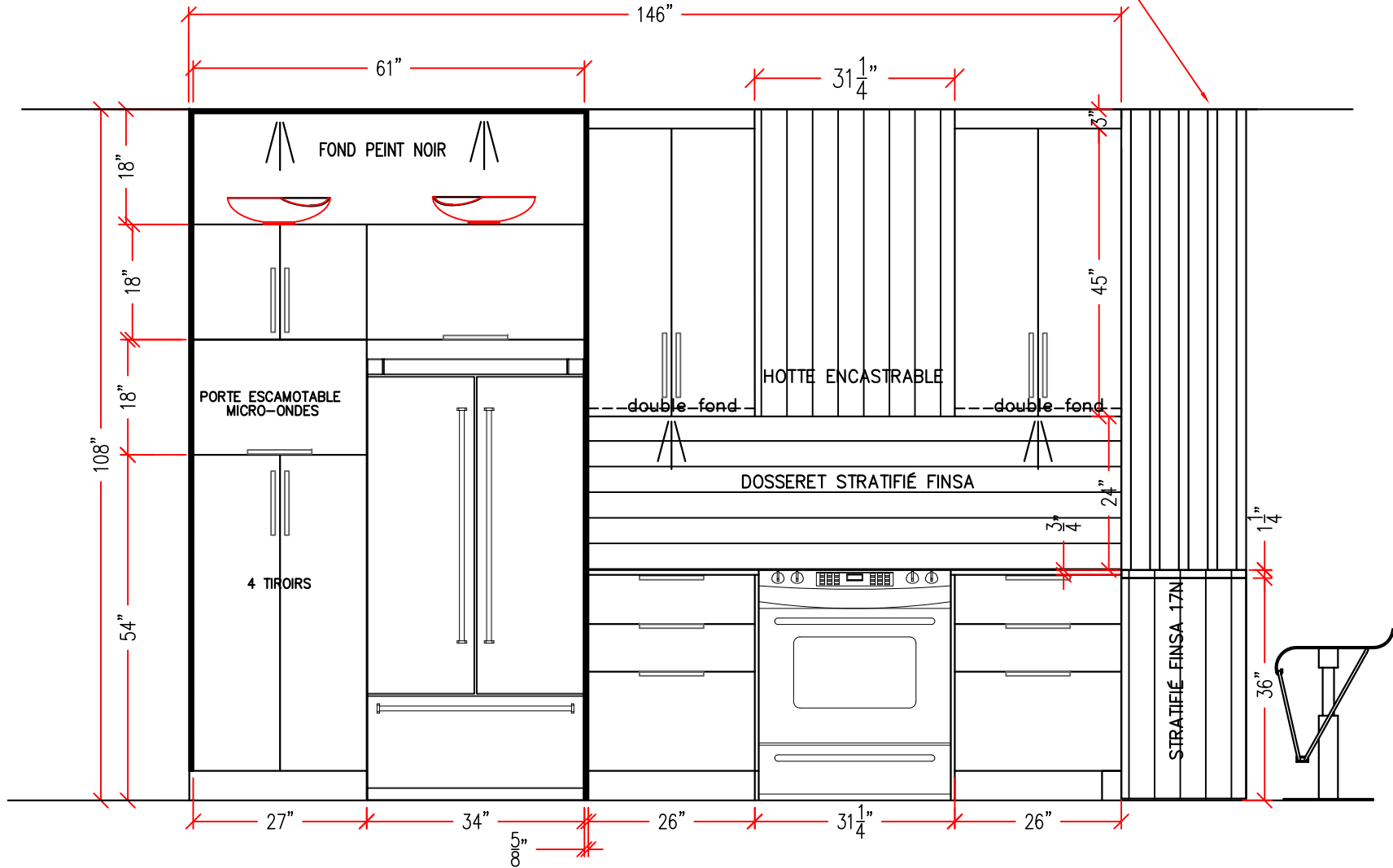

THERMO BLANC 104
MODÈLE 1000 F
POIGNEÉS V0117-128 L24

QUARTZ HORS CONTRAT
DOSSERET STRATIFIÉ FINSA 17N
CACHE DUCT MÉLAMINE FISA 17N

ÉLÉVATION CUISINE
CONDO 303
ST-CATHERINE

CONDO 303

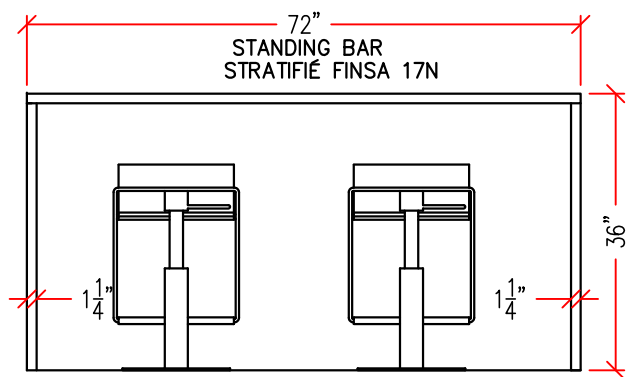
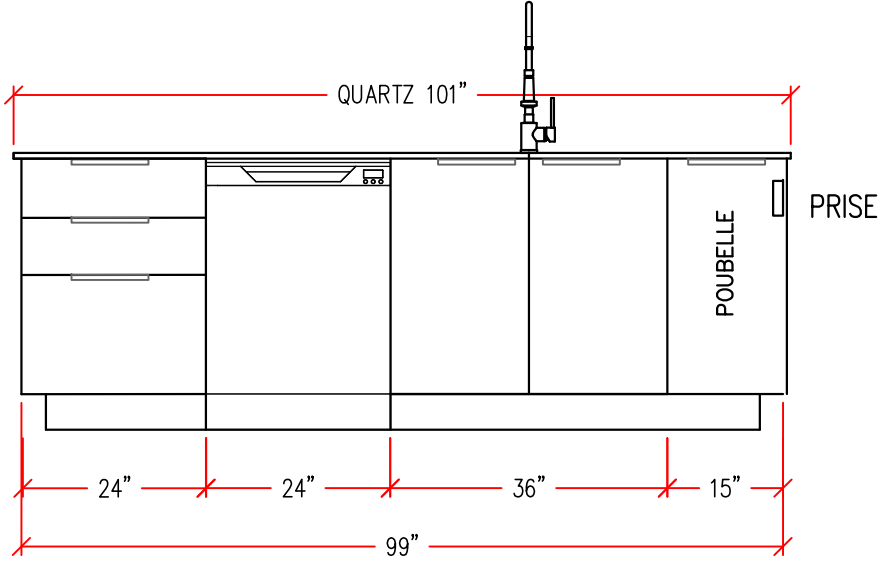
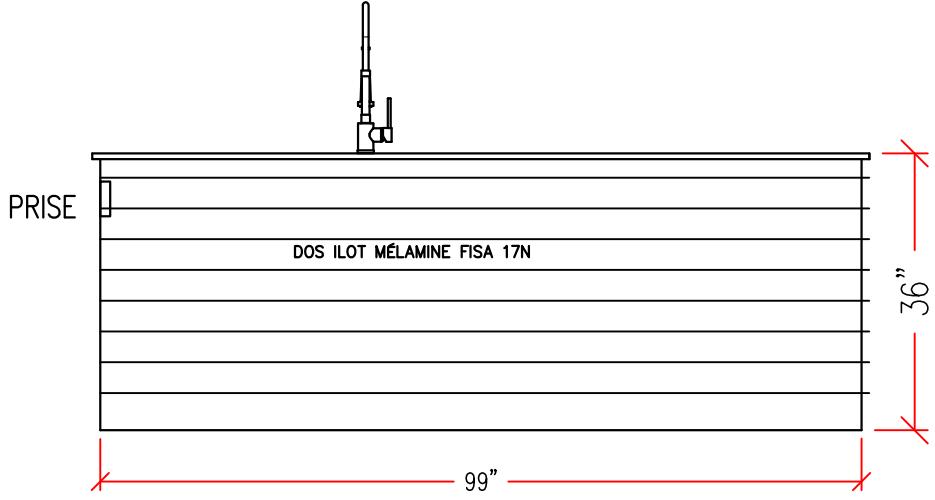

PLAN ILOT ET STANDING BAR
ÉLÉVATION
CONDO 303
ST-CATHERINE

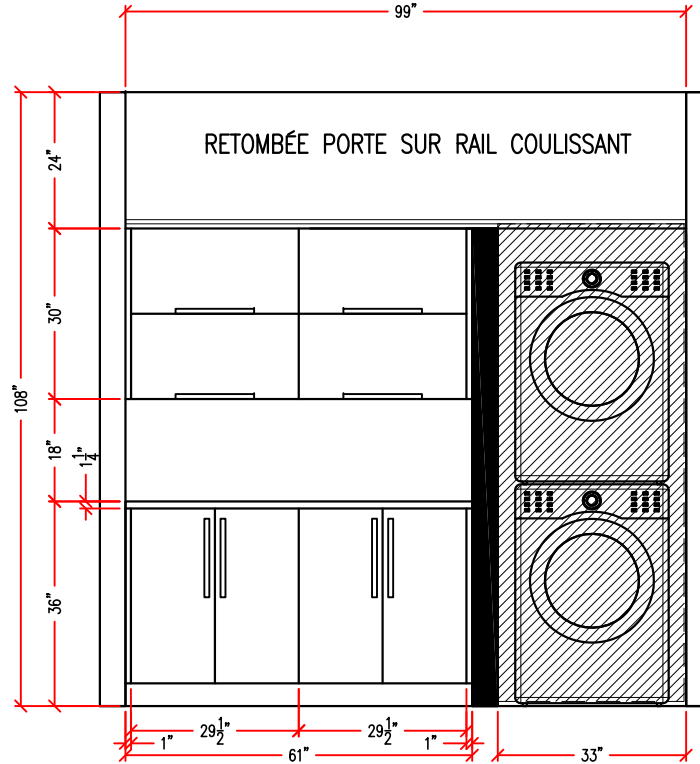
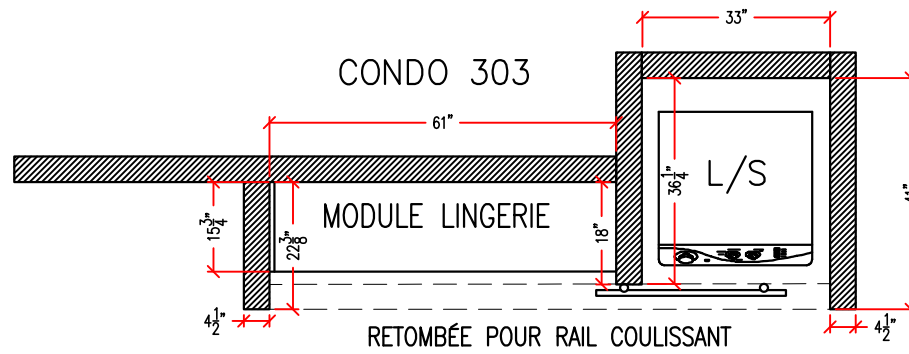

THERMO BLANC 104
 MODELE 1000 F
 POIGNEÉS V0117-128 L24
 COMPTOIR STRATIFIÉ MATCH FINSA 17N

PLAN SALLE DE BAIN
 CONDO 303
 ST-CATHERINE

CONDO 303

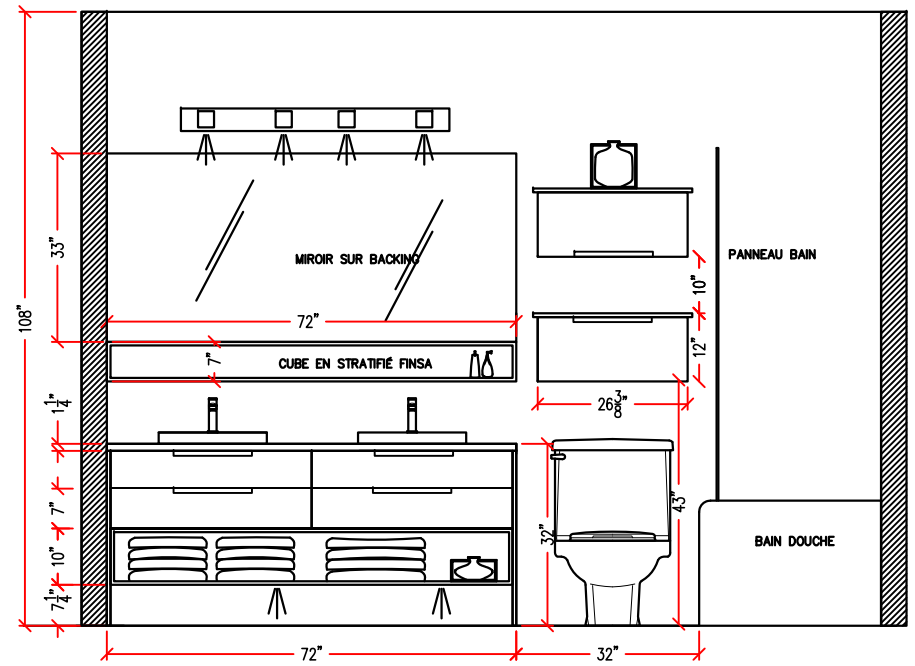
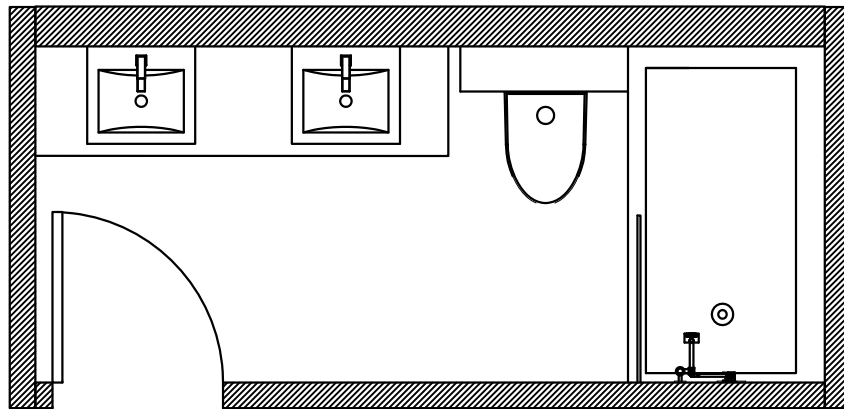

VANITÉ ET COTÉ MÉLAMINE FINSA 17N
 PHARMACIE MÉLAMINE FINSA 17N
 POIGNÉES V0117-128 L24

COMPTOIR STRATIFIÉ MATCH FINSA 17N
 CUBE DE 7" EN STRATIFIÉ MATCH FINSA 17N
 DESSUS PHARMACIE EN STRATIFIÉ MATCH FINSA 17N

PLAN SALLE DE BAIN
 CONDO 303
 ST-CATHERINE

CONDO 303

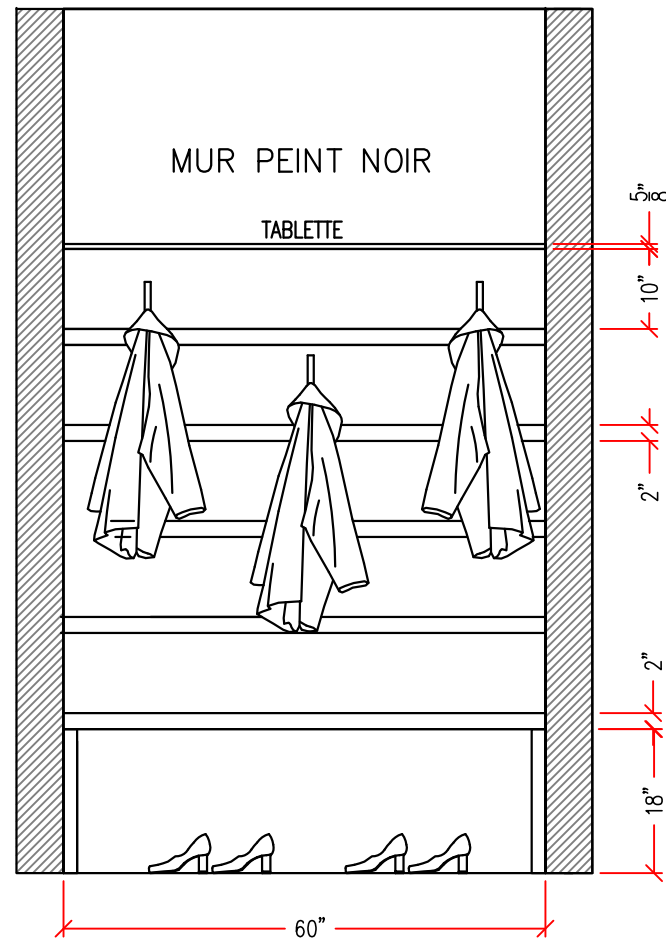
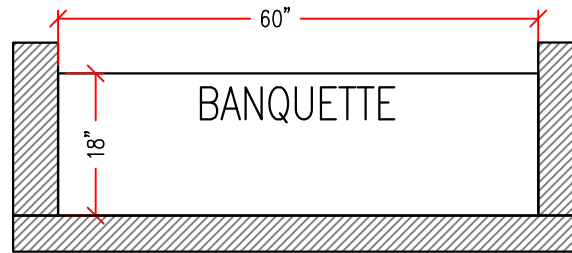

PLAN MUD ROOM
CONDO 303
ST-CATHERINE

DESSUS BANQUETTE FINSA 17N
MÉLAMINE FINSA 17N
CROCHET NOIR

CONDO 303 MEZZANINE

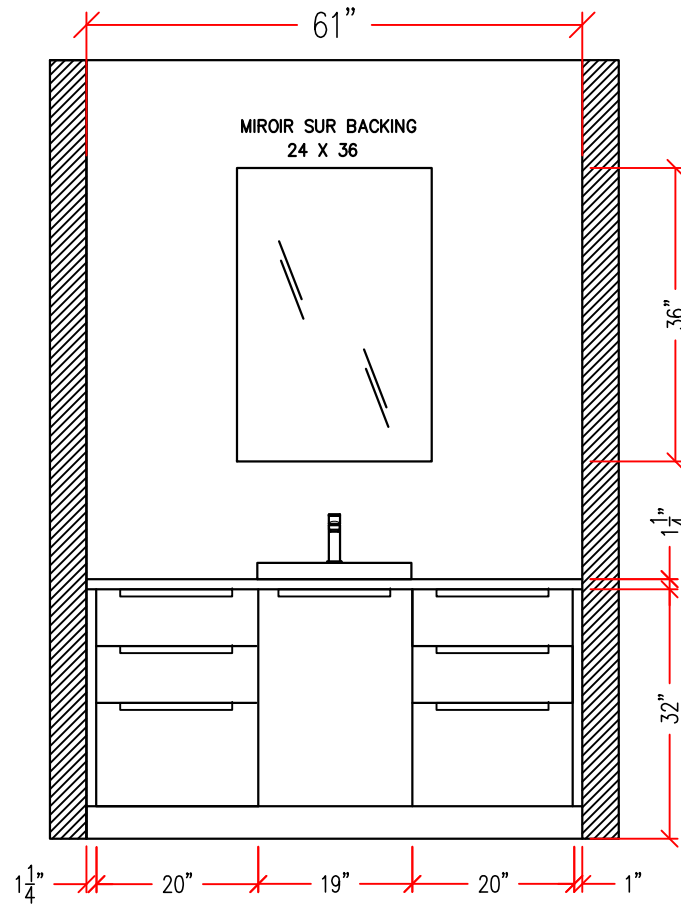

MÉLAMINE FINSA 17N
COMPTOIR STATIFIÉ FINSA 17N
POIGNEÉS VO117-128 L24

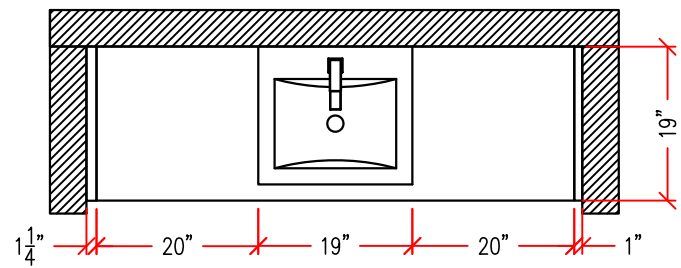

PLAN SALLE DE BAIN
MEZZANINE
CONDO 303
ST-CATHERINE